



Congratulations on your new POWERJET product. We are proud to have you as our customer and will strive to provide you with the best service and reliability in the industry. This product is backed by our extensive warranty and world-wide service network. To locate your nearest distributor or service agency call **0800 387 678**, or email us at info@euroquip.co.nz.

PowerJet 3000RS

**ULTRA HIGH
PRESSURE
CLEANER**



**Operating
Instructions**

Contents

Introduction.....3
Environmental protection.....3
Scope of product.....3
Description of symbols.....3
Specifications.....3
Safety rules.....4
Hazard symbols and meanings.....4
Unpacking.....6
Carton contents.....6
Assembly.....7
Attaching the handle.....7
Checking the engine oil.....7
Filling the fuel tank.....8
Connecting hose and water supply to pump.....8
Inlet water supply requirements.....9
Operating checklist.....9
Starting the machine.....10
Stopping the machine.....10
Nozzle installation selection.....10
Selecting the proper nozzle.....11
Cleaning & applying chemicals.....12
Pressure washer rinsing.....13
Cleaning horizontal surfaces.....13
Cleaning vertical surfaces.....13
Removing paint.....13
Cleaning radiator fins.....14
General maintenance.....14
Engine maintenance.....16
Pump maintenance.....16
Service Chart.....17
Storage.....17
Protecting the pump.....17
Troubleshooting.....18
Warranty.....21

Introduction

Your new POWERJET High Pressure Cleaner will more than satisfy your expectations. It has been manufactured under stringent quality standards to meet superior performance criteria. You will find your new tool easy and safe to operate, and, with proper care, it will give you many years of dependable service.

CAUTION:

Carefully read through this entire Instruction Manual before using your new POWERJET High Pressure Cleaner. Take special care to heed the Cautions and Warnings.

Your High Pressure Cleaner has many features that will make your job faster and easier. Safety, performance, and dependability have been given top priority in the development of this tool, making it easy to maintain and operate.

IMPORTANT:

Your POWERJET 3000RS is shipped without engine oil. **Please ensure you fill the machine with oil as per the instructions on page 7 before use.**

Environmental Protection

Recycle unwanted materials instead of disposing of them as waste. All tools, hoses and packaging should be sorted, taken to the local recycling centre and disposed of in an environmentally safe way.



Scope Of Product

This product is suited for home and domestic cleaning jobs around the house and garden, like decks, driveways and vehicles.

Description Of Symbols

The rating plate on your tool may show symbols. These represent important information about the product or instructions on its use.



Wear hearing protection.
Wear eye protection.
Wear breathing protection.



Z1085

Conforms to relevant standards for electromagnetic compatibility.

Specifications

Pressure:	2900 PSI (max.)
Flow Rate:	8.8 L/min (max.)
Engine:	6.5 HP OHV 4 Stroke
Fuel Tank Capacity:	3.6L
Displacement:	196cc
Fuel Type:	Unleaded petrol
Engine Oil Type:	SAE30 4 Stroke
Detergent:	Use detergent approved for pressure washers
Water Supply Temp:	Not to exceed 40° C
Operation Noise Level:	70dBA
Net Weight:	40kg

Read this manual carefully and become familiar with your pressure washer. Know the applications, the limitations and any hazards involved.

Every effort has been made to ensure that information in this manual is accurate and current. However we reserve the right to change, alter or otherwise improve the product and this document at any time without prior notice.

Safety Rules

 This is the safety alert symbol. It is used to alert you to potential personal injury hazards. Obey all safety messages that follow this symbol to avoid possible injury or death.



The safety alert symbol () is used with a signal word (**DANGER, CAUTION, WARNING**), a pictorial and / or a safety message to alert you to hazards. **DANGER** indicates a hazard which, if not avoided, will result in serious injury or even death. **WARNING** indicates a hazard which, if not avoided, could result in serious injury or death. **CAUTION** indicates a hazard which, if not avoided, might result in minor or moderate injury. **CAUTION**, when used without the alert symbol, indicates a situation that could result in equipment damage. Follow safety messages to avoid or reduce the risk of injury or death.

 **WARNING: The engine exhaust from this product contains chemicals known to cause cancer, birth defects or other reproductive harm.**

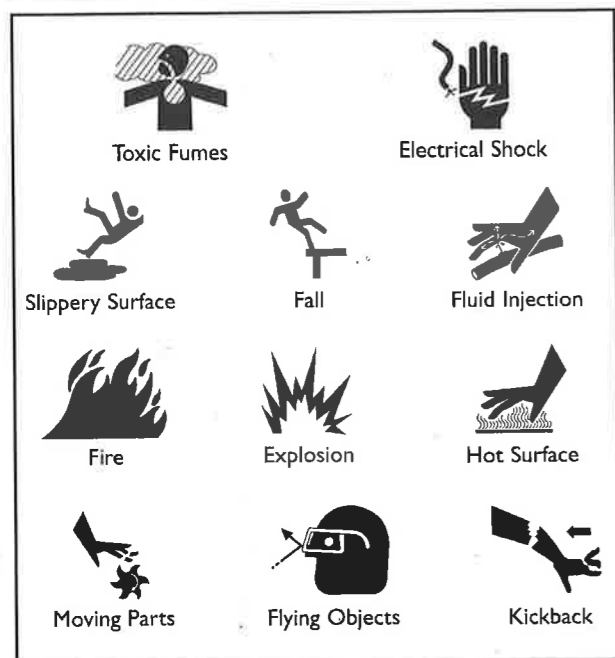
Hazard Symbols and Meanings





DANGER! Running engine gives off carbon monoxide, an odourless, colourless, poison gas.

 **Some chemicals or detergents may be harmful if inhaled or ingested, causing severe nausea, fainting or poisoning.**
 **Breathing carbon monoxide will cause nausea, fainting or death.**

- Operate pressure washer ONLY outdoors.
- Use a respirator or mask whenever there is a chance that vapours may be inhaled.
- Read all instructions with mask so you are certain the mask will provide the necessary protection against inhaling harmful vapours.

 **WARNING! Spray contact with electrical wiring can result in electrocution.**

 • Keep water spray away from electric wiring or fatal electric shock may result.

 **WARNING! Use of pressure washer can create puddles and slippery surfaces.**

 **High pressure spray could cause you to fall if you are too close to the cleaning surface.**

- Keep spray tip between 8 to 24 inches away from cleaning surface.
- Operate this unit on a stable surface.
- The cleaning area should have adequate slopes and drainage to reduce the possibility of a fall due to slippery surfaces.
- Be extremely careful if you must use the pressure washer from a ladder, scaffolding or any other relatively unstable location.
- Firmly grasp spray gun with both hands when using high pressure spray to avoid injury if gun recoils.

Warranty

Whilst every effort is made to ensure your complete satisfaction with this tool, occasionally, due to the mass manufacturing techniques, a tool may not live up to our required level of performance and you may need the assistance of our service department.

This product is warranted for a 12 month period for home domestic use from the date of the original purchase. If found to be defective in materials or workmanship, the tool or the offending faulty component will be replaced free of charge with another of the same item. A small freight charge may apply. Proof of purchase is essential.

We reserve the right to reject any claim where the purchase cannot be verified. This warranty does not include damage or defects to the tool caused by or resulting from abuse, accidents, alterations or commercial or business use. It also does not cover any bonus items or included accessories. Only the high pressure cleaner is covered under this warranty.

Please ensure that you store your receipt in a safe place. Conditions apply to the above warranty.

- 1. DURATION:** The manufacturer warrants that it will repair or replace, at no charge for parts or labour, the POWERJET 3000RS High Pressure Cleaner, if proven defective in material or workmanship, during the following time period(s) after date of original retail purchase:

For 1 Year:
The POWERJET 3000RS High Pressure Cleaner (excluding accessories)

- 2. WHO GIVES THIS WARRANTY (Warrantor):**

EUROQUIP NZ	EUROQUIP AUSTRALIA
Service Line	Service Line
++64 3 547 8409	1-800 040 947
- 3. WHO RECEIVES THIS WARRANTY (Purchaser):**
 The original purchaser of this POWERJET product.
- 4. WHAT IS COVERED UNDER THIS WARRANTY:**
 Defects in material and workmanship which occur within the duration of the warranty period.
- 5. WHAT IS NOT COVERED UNDER THIS WARRANTY:**
 - A. Implied warranties, including those of merchantability and FITNESS for a particular purpose are limited in duration to this express warranty. After this period, all risks of loss, from whatever reason, shall be on the purchaser.**

B. ANY INCIDENTAL, INDIRECT, OR CONSEQUENTIAL LOSS, DAMAGE, OR EXPENSE THAT MAY RESULT FROM ANY DEFECT, FAILURE OR MALFUNCTION OF THIS PRODUCT.

C. This warranty does not apply to any accessory or consumable items included with the product which are subject to wear from usage; the repair or replacement of these items shall be at the expense of the owner. These items include, but are not limited to: sparkplugs, seals, o-rings, lances, nozzles, thermal dump valves, hoses etc. In addition, this warranty does not extend to any damage caused by the untimely replacement or maintenance of any of the previously listed CONSUMABLE parts.

D. Any failure that results from accident, purchaser's abuse, neglect or failure to operate products in accordance with instructions provided in the owner's manual(s) supplied with the product.

E. Pre-delivery service, i.e. assembly and adjustment.

6. RESPONSIBILITIES OF WARRANTOR UNDER THIS WARRANTY: Repair or replace, at Warrantor's option, products or components which have failed within duration of the warranty period.

7. RESPONSIBILITIES OF PURCHASER UNDER THIS WARRANTY:

A. Please call your re-seller or the number listed above for warranty assistance.

B. Provide dated proof of purchase and maintenance records.

C. All high pressure cleaners must be delivered or shipped to the nearest Service Agent or re-seller. Freight costs, if any, must be borne by the purchaser.

D. Use reasonable care in the operation and maintenance of the products as described in the owner's manual(s).

E. No warranty costs incurred will be considered for, or covered if Euroquip has not been contacted and prior permission for repair / replacement has been granted.

8. WHEN WARRANTOR WILL PERFORM REPAIR OR REPLACEMENT UNDER THIS WARRANTY: Repair or replacement will be scheduled and serviced according to the normal work flow at the servicing location and depending on availability of replacement parts.

Engine is running but pump won't build maximum pressure or has irregular pressure:	
Faucet closed:	Open faucet
Unit has been stored in freezing temperature:	Thaw out unit completely
Inadequate water supply:	Provide a minimum of 12L/min at 20 PSI
Water inlet screen clogged:	Clean screen
Kink in garden hose:	Straighten garden hose
Wand nozzle worn or damaged:	Replace nozzle
Air in pump:	Run with gun open & wand removed until steady stream of water is released
Unloader not set correctly	Adjust unloader to correct position
Suction or discharge valves clogged or worn out:	Clean or replace the suction or discharge valves
Bypass valve not operating effectively:	Clean the bypass valve
No intake of chemicals:	
Injection tube not securely inserted:	Push firmly into injector into unit
Tube cracked or split:	Replace tube
Wrong nozzle:	Switch to low pressure nozzle
Injector turned off:	Turn collar counter
Trigger will not move:	
Gun safety lock engaged:	Release safety lock
Water in crankcase:	
High humidity:	Change oil more frequently
Worn seals:	Change the oil seals
Noisy operation:	
Worn bearings:	Change the bearings
Air mixed with water:	Check inlet lines for restrictions and / or proper sizing
Rough / pulsating, operating with pressure drop:	
Inlet restriction:	Check system for stoppages, air leaks, correctly sized inlet plumbing to pump
Unloader:	Check unloader for proper operation
Air mix in water:	Check inlet lines for restrictions and or proper sizing
High crankcase temperatures:	
Wrong grade of oil:	Use recommended oil
Improper amount of oil in crankcase:	Adjust oil to proper amount

 **WARNING!** Fuel and its vapors are extremely flammable and explosive. Fire or explosion can cause severe burns or death.

WHEN ADDING FUEL

- Turn pressure washer OFF and let it cool at least 2 minutes before removing gas cap.
- Fill fuel tank outdoors.
- DO NOT overfill tank. Allow space for fuel expansion.
- Keep fuel away from sparks, open flames, pilot lights, heat, and other ignition sources.
- DO NOT light a cigarette or smoke.

WHEN OPERATING EQUIPMENT

- DO NOT tip engine or equipment at angle which causes fuel to spill.
- DO NOT spray flammable liquids.

WHEN TRANSPORTING OR REPAIRING EQUIPMENT

- Transport / repair with fuel tank EMPTY or with fuel shutoff valve OFF.

WHEN STORING FUEL OR EQUIPMENT WITH FUEL IN TANK

- Store away from furnaces, stoves, water heaters, clothes dryers or other appliances that have a pilot light or other ignition source because they can ignite fuel vapours.

 **WARNING!** Running engines produce heat and hot exhaust gases.

 Temperature of muffler and nearby areas can reach or exceed 150°F (65°C).

 Fire or severe burns can occur.

- DO NOT touch hot surfaces.
- Stay clear of exhaust gases.
- Allow equipment to cool before touching.
- Do not allow high pressure hose or inlet hose to come in contact with hot muffler.

 **WARNING!** The high pressure stream of water that this equipment produces can pierce skin and its underlying tissues, leading to serious injury and possible amputation.

- NEVER aim spray gun at people, animals or plants.
- DO NOT allow CHILDREN to operate pressure washer.
- NEVER repair high-pressure hose. Replace it with an equivalent rated hose.
- Keep high pressure hose connected to pump and spray gun while system is pressurised.

 **WARNING!** Starter and other rotating parts can entangle hands, hair, clothing, or accessories.

- DO NOT wear loose clothing, jewellery or anything that may be caught in the starter or other rotating parts.
- Tie up long hair and remove jewellery.

 **WARNING!** High pressure spray can cause paint chips or other particles to become airborne.

- Always wear eye protection when using this equipment or in vicinity of where equipment is in use.

 **WARNING!** Unintentional sparking can result in fire or electric shock.

 **WHEN ADJUSTING OR MAKING REPAIRS TO YOUR PRESSURE WASHER**

- Disconnect spark plug wire from spark plug and place wire where it cannot contact spark plug.

CAUTION: Excessively high or low operating speeds increase risk of injury and damage to pressure washer.

- DO NOT tamper with governed speed.
- DO NOT operate pressure washer above rated pressure.

CAUTION: A pressure washer produces a high pressure spray which increases risk of injury and damage to unit.

- DO NOT secure spray gun in open position.
- DO NOT leave spray gun unattended while machine is running.
- NEVER use a spray gun which does not have a trigger lock or trigger guard in place and in working order.
- Always be certain spray gun, nozzles and accessories are correctly attached.

CAUTION: High pressure spray may damage fragile items including glass.

- DO NOT point spray gun at glass when in jet spray mode.
- NEVER aim spray gun at plants.

CAUTION: Improper treatment of pressure washer can damage it and shorten its life.

- NEVER operate units with broken or missing parts, or without protective housing or covers.
- DO NOT by-pass any safety device on this machine.
- Before starting pressure washer in cold weather, check all parts of the equipment to be sure ice has not formed there.
- NEVER move machine by pulling on high pressure hose. Use handle provided on unit.

- Check fuel system for leaks or signs of deterioration, such as chafed or spongy hose, loose or missing clamps, or damaged tank or cap. Correct all defects before operating pressure washer.

Unpacking

Due to modern mass production techniques, it is unlikely that your POWERJET Power Washer is faulty or that a part is missing. If you find anything wrong, do not operate the tool until the parts have been replaced or the fault has been rectified. Failure to do so could result in serious personal injury.

IMPORTANT: Read entire operating manual before you attempt to assemble or operate your new pressure washer.

Removing Pressure Washer from Carton

- Remove high pressure hose, handle, and parts included with pressure washer.
- Slice two corners from end of carton from top to bottom so it can be folded down flat, remove all packing material.
- Remove pressure washer from carton.

Carton Contents

- Main Unit
 - High Pressure Hose
 - Spray Gun
 - Nozzle Extension with Quick Connect Fitting
 - Handle
 - Wheel / Axle Kit
 - Parts Bag with fittings
- Parts Bag includes the following:
- 4 x multi-coloured Quick Connect Spray Tips
 - Owner's Manual

Problems with Detergent

Problems with use of detergent are often caused by incorrect procedures of operator. Problems encountered that involve the use of cleaning agents can often be attributed to one or more of the following:

1. Hose is not fully submerged in solution: If the tube isn't fully immersed, the unit will be picking up air.
2. Injection valve is closed: The detergent valve must be open in order to pick up detergent.
3. Wrong type of detergent: Only soaps designed specifically for pressure washers should be used. Household detergents could damage the pressure washer.



Troubleshooting Tips

1. If the pump is running but produces no flow, try **priming the pump.**
 - a) To prime the pump, keep suction at a minimum and keep the discharge line open.
 - b) Open and close the spray gun trigger repeatedly to aid the priming process.
2. A **chattering noise** usually indicates a restricted water supply or air leaks.
 - a) Check for kinks or leaks in the hoses
 - b) Look for a plugged or damaged inlet water filter
 - c) If the filter has been damaged, sediment may have entered the pump. The sediment will be lodged in the inlet valve(s) and must be removed.
3. Damage to the pump can result from
 - a) Inadequate water supply,
 - b) Vacuum lift too high, or
 - c) Excessive water temperature.
4. Check the pump crankcase for correct oil level and for oil contamination. If oil appears milky, water has entered the oil and the piston seals should be replaced.

Engine will not start or stops while operating:

Low-oil shutdown:	Fill engine with oil
Engine switch not in 'ON' position:	Turn switch 'ON'
Pressure built up in hose:	Squeeze trigger while starting
Engine is overloaded:	
Nozzle partially blocked:	Clean Nozzle
Excessive pressure:	Shorten the spring coil on the unloader
Pressure increases when gun is locked:	
Bypass valve blocking:	Clean the bypass valve

Troubleshooting

NOTE: Most problems with pressure washers are not a malfunction of the pump or motor!! ALWAYS trouble shoot from water source and/or nozzle towards the pump and motor. Example: Check water supply and nozzle if pressure fluctuates, unit is noisy or does not reach full pressure.

Follow these trouble shooting rules closely

With proper care and use of the pressure washer, the unit should remain free of problems. Most problems are caused by careless or improper use of equipment. Operation of the unit without an inlet water supply will result in damage to seals and other components. Another common cause of damage is running unit for long periods with spray gun trigger in its "Closed" position.

The latter can result in high water temperatures, resulting in damage to seals and other components.

Cavitation

If the water pressure falls below a certain point (called vapor pressure) the water will begin to boil even though the temperatures are below normal boiling point. Tiny bubbles of vapor will then form in the boiling water. If the vapor bubbles are carried away to a higher pressure area in the system the vapor will condense again and leave a cavity in the midst of the flow. The surrounding water will then rush in to fill these cavities. Extremely high local pressures are then created (up to 100,000 PSI). Such high pressures may result in erosion, turbulence, noise, vibration, and excess wear and tear on the pump.

The pump inlet, where the pistons pull the water in, is very susceptible to cavitation problems.

Anything that obstructs the flow of water into the pump can result in cavitation such as:

- A clogged water inlet filter
- Inlet piping or hoses that are too small

- Excessive numbers of restrictions in the water inlet (such as too many valves, or too many bends).
- Excessive turbulence or heat

Some Pressure Washer Problems

Some of the problems that might occur in a pressure washer system are as follows:

- Failure of the unit to produce pressure
- Erratic pressure
- Chattering
- Reduction in pressure
- Low water volume

When a problem arises don't remove the pump immediately and start replacing parts. First check the following possible causes of the problem:

- Make sure the water supply is turned on and the water supply is adequate.
- Make sure the water inlet hose is not kinked or damaged.
- Check the inlet water filter. Clean or replace if necessary.
- Make sure the water supply is not too hot. Inlet water temperature should not exceed 40° C.
- If a detergent is being used, make sure the detergent hose is submerged and not drawing air into the system. If detergent is not being used, the chemical injector valve should be turned off.
- Make sure the unloader/regulator valve is properly adjusted.
- Make sure the pump outlet hose is not leaking and is not blocked.
- Check the wand and high pressure hose quick couplers for missing O-rings.
- Check that the nozzle is clear and unobstructed.

Assembly

To prepare your pressure washer for operation, you will need to perform the following:

1. Attach handle to main unit
2. Attach axle / wheels
3. Add oil to engine
4. Add fuel to fuel tank
5. Connect high pressure hose to spray gun and pump
6. Connect water supply to pump
7. Connect nozzle extension to spray gun
8. Select and install desired quick connect spray tip.

Attaching the Handle

1. Place handle assembly onto handle supports connected to main unit. Ensure holes in handle tube align with the locking pins in the frame and the spring-loaded locking pins are engaged with the handle.

NOTE: It may be necessary to move the handle supports from side to side in order to align the handle so it will slide over the handle supports.

2. Insert multi-coloured spray tips in spaces provided in handle.

Checking the Engine Oil

IMPORTANT: All washers are shipped without engine oil. **USE A QUALITY SAE30 GRADE OIL.**

1. Place unit on a level surface
2. Remove oil filler cap / dipstick (A) and wipe it clean.
3. Insert oil filler cap / dipstick into filler neck, but DO NOT screw it in.
4. Remove dipstick. Proper oil level is at mid-point of dipstick (A). Add oil if necessary to bring oil level to top of threads (B). Oil capacity = 600ml.
5. Install and tighten cap.

NOTE: Check oil often during engine break-in.

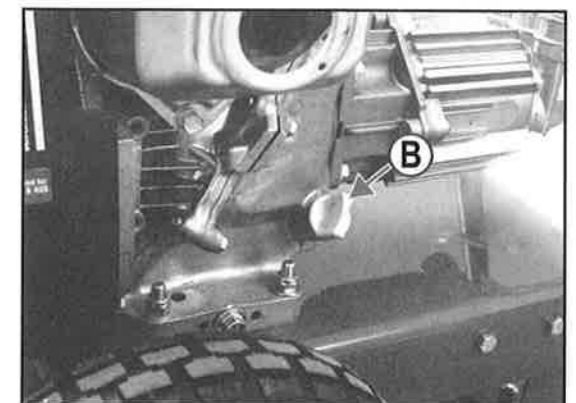
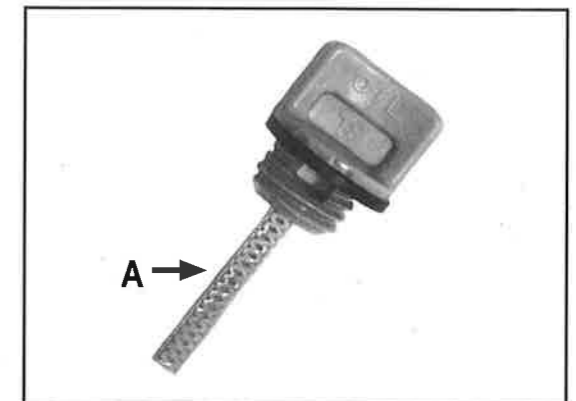

! CAUTION! Any attempt to crank or start the engine before it has been properly filled with the recommended oil will result in equipment failure. Damage to equipment resulting from failure to follow this instruction will void warranty.

Filling the Fuel Tank

CAUTION: Risk of fire. Handle fuel carefully.

Do not add fuel when product is operating. Stop engine and allow engine to cool for two minutes before refueling. Hot surfaces can cause burns and ignite spilled fuel. Do not touch muffler.

- Fill fuel tank outdoors away from flames and open sparks.
- Do not smoke when filling fuel tank.
- Do not overfill fuel tank. (There should be no fuel in filler neck.)
- Avoid spilling fuel. Wipe clean after refueling.
- Move from refueling area before starting.
- Prevent fires by keeping engine clean of accumulation, grease, trash and debris.

IMPORTANT: Do not permit dirt or other foreign matter to enter the fuel system. This will cause hard starting, poor performance and engine damage. Always use clean fuel storage containers and funnels.



Use clean, fresh, lead-free gasoline. Do not use stale gasoline or gasoline that has been stored for a long time. Stale gasoline does not vaporise properly, causing hard starts. Use of Fuel Set gasoline stabilizer is highly recommended. Use of leaded gasoline or gasohol is NOT recommended.

Connect Hose & Water Supply To Pump

IMPORTANT: To avoid pump damage, you must assemble the nozzle extension to the spray gun and attach all hoses before you start the engine.

1. Uncoil high pressure hose and attach the end of the hose to base of spray gun (Fig. 2). Thread hose fitting on in clockwise direction and tighten moderately.

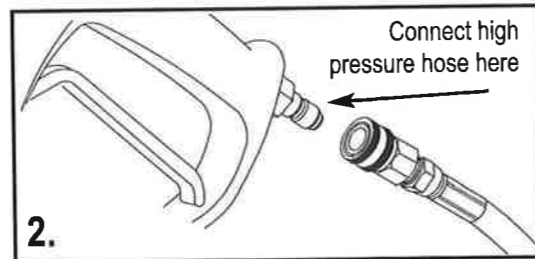

3. Similarly, attach other end of high pressure hose to high pressure outlet on pump.
4. Before connecting garden hose to water inlet, inspect inlet screen (Fig. 3). Clean screen if it contains debris, replace if damaged. **DO NOT RUN PRESSURE WASHER IF SCREEN IS DAMAGED.**
5. Run water through garden hose for 30 seconds to clean out any debris. Turn off water.

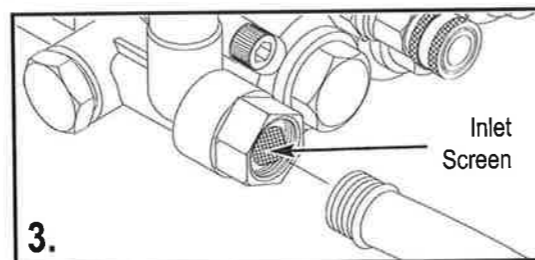

IMPORTANT: DO NOT siphon standing water for the water supply. Use ONLY cold water (less than 40°C).

6. Connect garden hose (not to exceed 50 feet in length) to water inlet (Fig. 3).

Service Chart

	First Month or 5 hours	Every 3 Months or 25 hours	Every 6 Months or 50 hours	Every Year or 100 hours	Every Two Years or 250 hours
Clean Air Filter		X			
Change Air Filter			X		
Change Engine Oil	X		X		
Clean and Gap Spark Plug			X		
Change Spark Plug				X	
Clean Sediment Cup			X		
Adjust Valve Clearance				X	
Clean Fuel tank and filter				X	
Check Fuel Tube					X
Clean Detergent Strainer		X			
Clean Inlet Water Screen		X			

1. Perform engine oil change after first 5 hours of use and then at recommended intervals. Change engine oil every 25 hours when used under heavy load or in high ambient temperatures.
2. Service more frequently when used in dusty areas.
3. Air filter element may require replacement earlier in dusty areas. A dirty air filter reduces engine performance.
4. Unit should be serviced by authorised dealer unless owner has proper tools and is mechanically proficient and experienced in the repair of pressure washers.

Storage

Water shouldn't remain in unit for long periods of time. Sediments or minerals can deposit on pump parts and 'freeze' pump action.

If you do not plan to use the pressure washer for more than 30 days, follow this procedure:

1. Flush detergent siphoning tube by placing filter into a pail of clean water while running pressure washer in low pressure mode. Flush for one to two minutes.
2. Shut off engine and let it cool, then remove high pressure and garden hoses. Disconnect spark plug wire from spark plug.
3. Empty pump of liquids by pulling engine recoil handle about 6 times. This should remove most liquid in pump.
4. Use pump saver to prevent corrosion build up and freezing of pump.

Protecting the Pump

To protect the pump from damage caused by mineral deposits or freezing, use PumpSaver to treat pump. This prevents freeze damage and lubricates pistons and seals.

NOTE: PumpSaver is available as an optional accessory. It is not included with the pressure washer. Contact the nearest authorized service center to purchase PumpSaver.

CAUTION! You must protect your unit from freezing temperatures. Failure to do so will permanently damage your pump and render your unit inoperable. Freeze damage is not covered under warranty.

To use PumpSaver, make sure the pressure washer is turned off and disconnected from supply water. Read and follow all instructions and warnings given on the PumpSaver container.

NOTE: PumpSaver will drip from pump after treatment and will stain wood and concrete.

CAUTION! Read and follow all cautions and warnings on the PumpSaver can label. Always wear eye protection when using PumpSaver.

NOTE: If PumpSaver is not available, draw RV anti-freeze (non-alcohol) into the pump by pouring the solution into a 3-foot section of garden hose connected to inlet adapter and pulling recoil handle twice.

Engine Maintenance

See the engine owner's manual for instructions on how to properly maintain the engine.



KEEP OUT OF REACH OF CHILDREN. DON'T POLLUTE. CONSERVE RESOURCES. RETURN USED OIL TO COLLECTION CENTRES.

CAUTION! Avoid prolonged or repeated skin contact with used motor oil. Used motor oil has been shown to cause skin cancer in certain laboratory animals.

CAUTION! The maximum engine RPM has been set at the factory. TAMPERING WITH ENGINE GOVERNOR WILL VOID WARRANTY.

Pump Maintenance

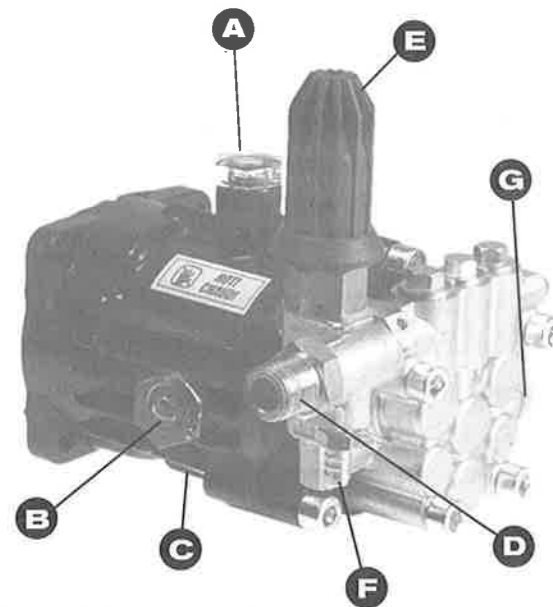

Pump Components

- A. Oil Filler Bung
- B. Oil Sight Glass
- C. Oil Drain Bung (obscured)
- D. Water Outlet
- E. Unloader (Pressure) Adjustment Knob
- F. Detergent Pickup
- G. Water Inlet (partially obscured)

Check Oil Level

The oil level in the pump can be viewed by checking the oil sight glass (B) on the side of the pump. The oil level should be up to the middle of the sight glass with the machine on level ground.

Oil Change Periods

The oil in the pump should be changed after the first two hours of use. Following this, an oil change should be performed when the oil becomes discoloured or every 50 hours of use, whichever event occurs first.

Changing the Oil

1. Ensure the machine is on a level stable surface
- NOTE:** Performing an oil change will be easier if the machine has been run and the pump is still warm.
2. Place a suitable container under the pump and remove the drain bung (C).
 3. Replace the oil drain bung once all the old oil has drained from the pump. Dispose the waste oil in an environmentally responsible manner, ensuring local & governmental regulations are adhered to.
 4. Re-fill the pump with a quality, fresh, low foaming SAE30 oil through the oil filler hole (A) and refit the oil filler bung. Oil capacity = 120mls.

Pressure Adjustment

Pump pressure may be adjusted by turning the unloader adjustment knob (E).

CAUTION! Do not exceed the manufacturer's maximum pressure by increasing the unloader adjustment range. (This will void pump warranty.)

Pump failure is most commonly due to lack of care in operation and poor or no maintenance rather than manufacturing defects. Issues caused by operator error and/or lack of correct maintenance will not be considered under warranty.

CAUTION! There **MUST** be at least ten feet of unrestricted garden hose between the pressure washer inlet and any flow shut off device, such as a 'Y' shut-off connector or other convenience-type water shut-off valve. Damage to equipment resulting from failure to follow this instruction will void warranty.

7. Turn ON water and squeeze trigger on spray gun to purge pump system of air and impurities.

Inlet Water Supply Requirements

1. Inlet water supply must be a minimum of 20 PSI (1.4 bar). Attempting to operate the washer with less than adequate water supply will cause rapid wear of packings, valves and bearings that will dramatically shorten pump life. Symptoms of inadequate water supply are pump shuddering and flattening of the supply hose.
2. Inlet water flow must be at least 125% of pump rated flow (see the following table). Check volume by timing how long it takes to fill a 20 litre container. For example, a flow rate of 10 L /min would fill a 20 litre container in 2 minutes.
3. Water supply hose should be a good grade of garden hose with a minimum inner diameter of 12mm, and no longer than 15.24m. If a longer supply hose must be used, check to be certain flow is at least equal to the 'L/min Supply Required' value for your washer (See the following table).
4. If a non-pressurised (static draw) water supply is used, check to be certain flow is at least 125% of pump rated flow (see the following table).

In static draw situations, water flow rate (L/min) can be increased by elevating the water supply tank or changing to a larger inside diameter water supply hose.

5. Adding on extension to the supply hose will reduce water flow rates. Check for adequate water flow rate each time an extension is added. Water flow rates can be increased by using the largest possible internal diameter supply hose.

IMPORTANT: Inlet water temperature must not be more than 40°C or damage to the pump may result.

Washer	Rated Flow L/min	L/min Supply Required
PJ2000RS	6.4	10
PJ2500RS	8.8	12
PJ3000RS	8.8	12

Operating Checklist

IMPORTANT: Before starting the engine review the unit's assembly to confirm you have performed all of the following:

1. Make sure handle is in place and secure.
2. Check that oil has been added to proper level in engine crankcase and the pump.
3. Add proper fuel to fuel tank.
4. Check for properly attached hose connections.
5. Check to make sure there are no kinks, cuts, or damage to high pressure hose.
6. Provide a proper water supply (not to exceed 40°C) at an adequate flow.
7. Be sure to read all safety rules and how to use your pressure washer in the following sections before use.

If you have any problems operating your machine, please call the Technical Helpline on 0800 387 678.

Starting the Machine

⚠ WARNING! High pressure spray, improperly used could damage the equipment you wish to clean or the surrounding environment. Practice on scrap materials, gradually increasing pressure applied to the object by adjusting the nozzle or moving the nozzle closer to the object until it is cleaned without being damaged.

The manufacturer does not warranty damage caused by the consumer's failure to adjust or operate the machine in accordance with the instructions provided in the owners manual supplied with the machine.

Follow these instructions to operate the machine:

1. Use the operation checklist to help avoid personal injury and damage to the machine.
2. Prime the pump and purge air from the system by squeezing the gun trigger before starting the machine, with the unit attached to a pressure main. Let the water flow from the wand until air is purged from system.
3. If engine is equipped with fuel valve, turn valve to ON.
4. Close choke lever located on engine carburetor as per engine manufacturer instructions.
5. Turn engine switch to ON.
6. If engine is equipped with throttle lever, position lever to HALF THROTTLE.
7. For easier starting, squeeze the trigger on the spray gun allowing water to flow through the gun. This will relieve pressure in the pump allowing the motor to turn freely. Failure to follow this instruction may damage the pump or the recoil starter and this damage will not be covered under warranty.
8. Pull lightly on the starter grip until resistance is felt, then pull briskly. Repeat this step as necessary until engine starts.

9. As engine begins to warm up, gradually move the choke lever to OPEN.
10. If engine is equipped with throttle lever, position lever to FULL THROTTLE.
11. You are now ready to start cleaning with your pressure washer.

⚠ CAUTION! Always begin high pressure washing with nozzle at least four feet from object being cleaned. Gradually move nozzle closer to object until it is cleaned without damage.

Stopping the Machine

1. Run only clean water through the entire chemical/detergent system.
2. If engine is equipped with throttle lever, position lever to IDLE.
3. Turn engine switch to OFF.
4. If engine is equipped with a fuel valve, turn valve to CLOSED position.
5. Turn water supply to OFF.
6. Open gun to relieve pressure, and drain as much water as possible.
7. Remove inlet garden hose.
8. For safety and your liability protection, remove high pressure hose and store gun/wand in a secure place with this owners manual to eliminate the possibility of unauthorized and untrained personnel from operating the machine.

Nozzle Installation Selection

INSTALLING NOZZLE

⚠ CAUTION! To avoid injury from escaping fluids under pressure, relieve the pressure in the system by stopping the washer and depress-

Cleaning Detergent Siphoning Tube

If you used the detergent siphoning tube, you must flush it with clean water before stopping the engine.

1. Place chemical injection siphon/filter in a bucket full of clean water.
2. Attach black low pressure spray tip.
3. Flush for 1-2 minutes.
4. Shut off engine.

Check Gun and Nozzle Extension

Examine the hose connection to the spray gun and make sure it is secure. Test the trigger by pressing it and making sure it springs back into place when you release it. Put the safety latch in the on position and test the trigger. You should not be able to press the trigger.

Purge Pump of Air and Contaminants

To remove air from the pump, follow these steps:

1. Set up pressure washer as described in 'Preparing Pressure Washer For Use'. Connect water supply and turn water on.
2. Pull trigger on spray gun and hold.
3. When water supply is steady and constant, engage safety latch.

To remove contaminants from the pump, follow these steps:

1. Set up pressure washer as described in 'Preparing Pressure Washer For Use'. Connect water supply and turn water on.
2. Start engine according to instructions in 'To Start Pressure Washer'
3. Remove nozzle extension from spray gun.
4. Squeeze trigger on spray gun and hold.
5. When water supply is steady and constant, engage safety latch and reattach nozzle extension.

Nozzle Maintenance

A pulsing sensation felt while squeezing the spray gun trigger may be caused by excessive pump pressure. The principal cause of excessive pump pressure is a

spray tip clogged or restricted with foreign materials, such as dirt, etc.

To correct the problem, immediately clean the spray tips using the tools included with your pressure washer and follow these instructions:

1. Shut off engine and turn off water supply.
2. Remove spray tip from end of nozzle extension.
3. Remove in-line filter from other end of nozzle extension.
4. Use wire included in kit (or a small paper clip) to free any foreign material clogging or restricting spray tip (Fig. 9).

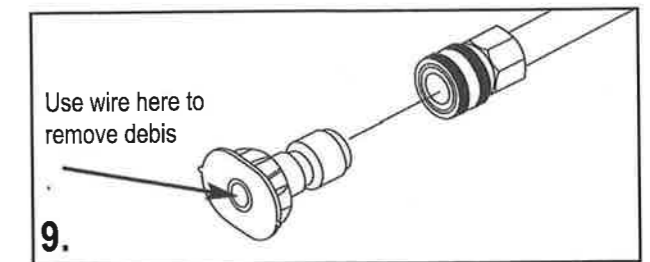

9.

5. Using a garden hose, remove additional debris by back flushing water through nozzle extension (Fig. 10). Back flush between 30 to 60 seconds.

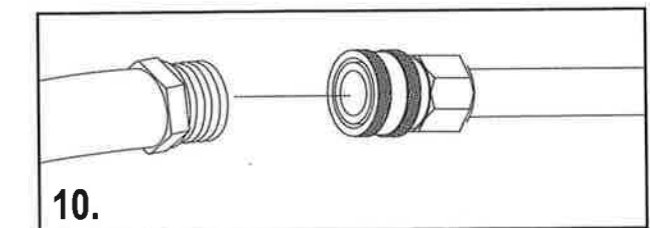

10.

6. Reinstall spray tip into nozzle extension.
7. Reconnect nozzle extension to spray gun.
8. Reconnect water supply, turn on water and start engine.
9. Test pressure washer by operating with each Quick Connect spray tip.

O-Ring Maintenance

Through the normal operation of your pressure washer, o-rings, which keep the connections of the hoses and spraygun tight and leak-free, may become worn or damaged.

To remove a worn or damaged o-ring; use a small flathead screwdriver to get underneath the o-ring and pry it off.

- Some remaining paint may curl up at the edges. These edges should be scraped with a steel brush or scraper just before painting.

Cleaning Radiator Fins

IMPORTANT: Some engine and radiator manufacturers may not permit cleaning radiators with a high pressure washer - refer to the equipments Operating Manual.

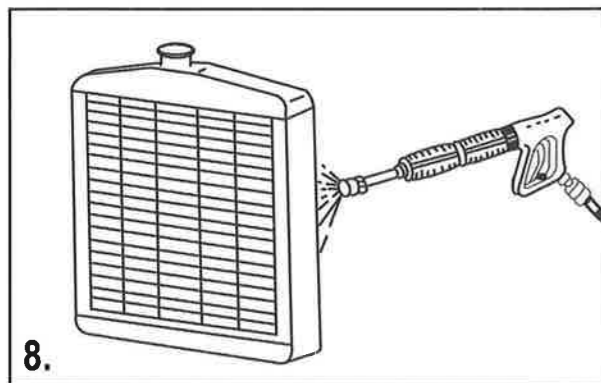

- Use clean water without detergent.

IMPORTANT: Spray straight into the radiator to prevent bending fins.

- If possible, direct spray in the direction opposite to normal air flow through the radiator.

General Maintenance

The pressure washer warranty does not cover items that have been subjected to operator abuse or negligence. To receive full value from the warranty, the operator must maintain the pressure washer as instructed in this manual.

- Some adjustments will need to be made periodically to properly maintain your pressure washer.
- All maintenance in this manual should be made at least once each season.
- If equipped with inflatable tires, keep the air pressure at the value marked on the tyre or within 15 and 40 psi.

Before Each Use:

- Check engine oil level.
- Check water inlet screen for damage.
- Check high pressure hose for leaks.
- Check detergent siphoning tube and filter for damage.
- Check spray gun, nozzle extension, and spray tips for leaks.
- Rinse out garden hose to flush out debris.

Check and Clean Inlet Screen

Examine the screen on the water inlet. Clean it if the screen is clogged or replace it if screen is damaged.

Check High Pressure Hose

The high pressure hose can develop leaks from wear, kinking, or abuse. Inspect the hose each time before using it. Check for cuts, leaks, abrasions or bulging of cover, damage or movement of couplings. If any of these conditions exist, replace the hose immediately.

! WARNING! The high pressure stream of water that this equipment produces can pierce skin and its underlying tissues, leading to serious injury and possible amputation. NEVER repair high pressure hose. Replace it. Replacement hose rating MUST exceed maximum pressure rating of unit.

Check Detergent Siphoning Tube

Examine the filter on the detergent tube and clean if clogged. The tube should fit tightly on the barbed fitting. Examine the tube for leaks or tears. Replace the filter or tube if either is damaged.

IMPORTANT: Simply shutting OFF engine will not release pressure in the system. When the engine has shut down, squeeze the trigger on the spray gun to relieve the pressure in the hose.

ing gun trigger. Lock trigger before changing or adjusting nozzle. Be sure nozzle is tightly attached before operating to help prevent nozzle release.

- Retract locking ring (A) of quick-connect fitting and insert male quick-connect fitting of nozzle (B).

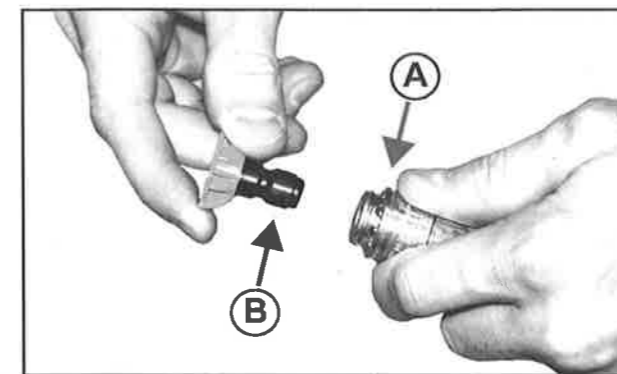

- Push ring forward and lock nozzle in place. Be sure nozzle is fastened to wand.

Selecting the Proper Nozzle

Pressure and volume are partially determined by the size of the orifice in the nozzle. Standard numbers are on the nozzles to indicate spray pattern and orifice size. For example, a nozzle stamped 50 has a 5° spray pattern and a 3.0 orifice.

0° NOZZLE - Red

This nozzle is a blasting nozzle, delivering a concentrated stream of water.



IMPORTANT: Care must be used to avoid gouging wood or damaging fragile surfaces.

Recommended uses are as follows:

- Removing stains from concrete, masonry, aluminum and steel.
- Remove weeds from sidewalk cracks.
- Remove caked-on mud from equipment.
- Clean lawn mower underdeck.

15° NOZZLE - Yellow

This nozzle provides a chiseling effect suitable for surface preparation. The spray should be directed at a 45° angle to the surface.



Recommended uses:

- Removing peeling paint.
- Removing mildew stains.

25° NOZZLE - Green

This is a flushing nozzle. It produces a brush effect with a wider spray pattern and less concentrated spray pressure than a 5° nozzle.



Recommended uses:

- Wet sweeping leaves from walks and drives.
- Cleaning stable floors.
- Cleaning swimming pool bottoms.
- Cleaning barbecue grill.

40° NOZZLE - White

This nozzle is a general purpose nozzle with a wide angle spray pattern. It is recommended for rinsing and light cleaning.



Recommended uses:

- Cleaning windows and aluminum siding.
- Vehicles (normal road dirt).
- Cleaning sidewalks, drives and patios.

**DETERGENT
INJECTOR NOZZLE
- Black (Brass)**

This nozzle must be used with and is included in the detergent injector kit.

This nozzle will allow a soft spray to soak on a surface with a liquid detergent.

For applying cleaning solution.

Recommended uses:

- Removing mildew and oxidation stain from houses
- Cleaning effervescent brick.



To apply detergent follow these steps:

1. Review spray tip use.
2. Prepare detergent solution as required by manufacturer.
3. Place chemical injection siphon/filter into detergent container.
4. Make sure black spray tip is installed.

NOTE: Detergent cannot be applied with the high pressure spray tips (White, Green, Yellow, or Red).

5. Make sure garden hose is connected to water inlet. Check that high pressure hose is connected to spraygun and pump; start engine.
6. Apply detergent to a dry surface, starting at lower portion of area to be washed and work upward, using long, even, overlapping strokes. **DO NOT** allow detergent to dry on (prevents streaking).
7. Allow detergent to soak in between 3-5 minutes before washing and rinsing. Reapply as needed to prevent surface from drying.

**Cleaning & Applying
Chemicals**

CAUTION! You must attach all hoses before you start the engine. Starting the engine without all the hoses connected and without the water turned ON will damage the pump. Damage to equipment resulting from failure to follow this instruction will void warranty.

IMPORTANT: Use soaps designed specifically for pressure washers. Household detergents could damage the pump.

CAUTION! Keep the chemical injection tube from coming in contact with the hot muffler. When inserting the filter into a detergent solution bottle, route the tube so as to keep it from inadvertently contacting the hot muffler.

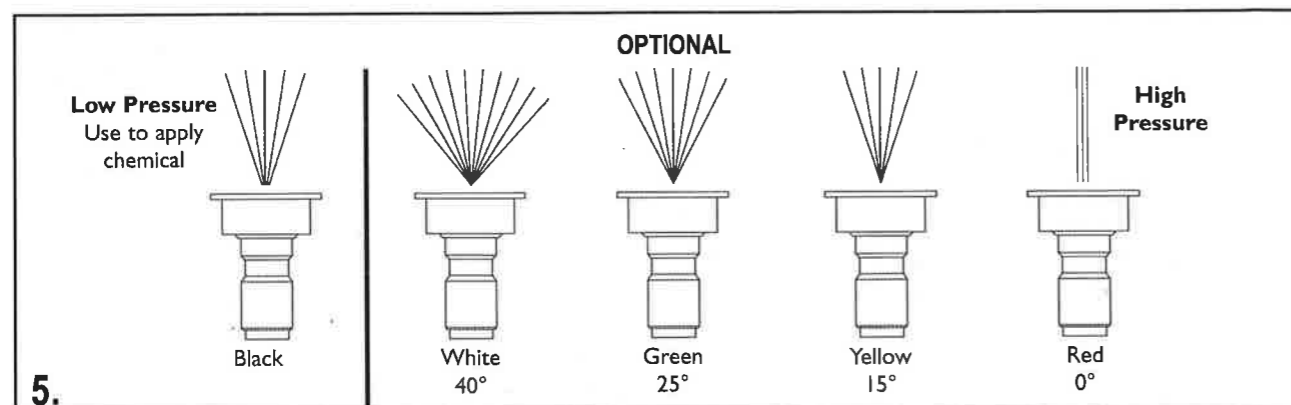

5.

**Pressure Washer
Rinsing**

After you have applied detergent, scour the surface and rinse it clean as follows:

1. Apply safety latch to spray gun.
2. Remove black chemical spray tip from nozzle extension.
3. Select and install desired high pressure spray tip following instructions in 'Selecting the Proper Nozzle'.
4. Apply high pressure spray to small area and check surface for damage. If no damage is found, you can assume it is okay to continue cleaning.
5. Start at top of area to be rinsed, working down with same overlapping strokes as you used for cleaning.

CAUTION! Never allow the pump to run for more than a 2 minute period without opening the gun. This will cause pump damage due to excessive water temperature and void the warranty.

**Cleaning Horizontal
Surfaces**

1. Move nozzle wand from side to side. Direct spray at an angle to force debris ahead and away from the cleared area (Fig. 6).

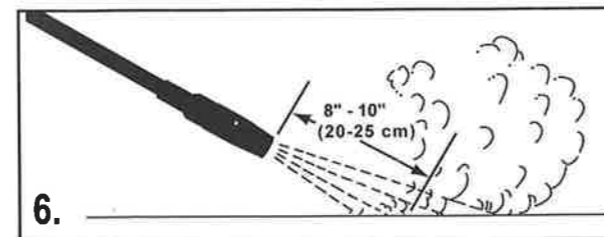

6.

2. Depending on the material to be removed and nozzle pressure, hold nozzle end 8 to 10 inches (20 to 25cm) from the surface and use slow, overlapping strokes.
3. If debris is easy to remove, move nozzle back to cover more area for faster cleaning.

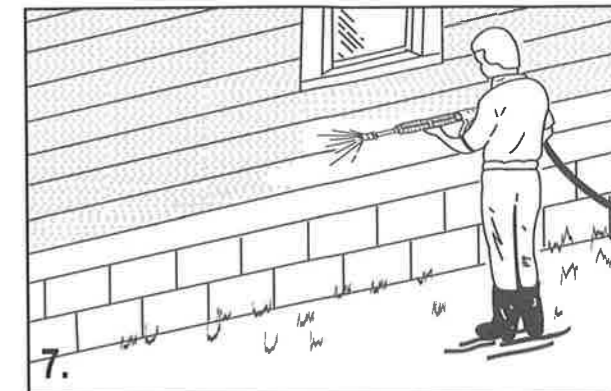

7.

**Cleaning Vertical
Surfaces**

IMPORTANT: Remember that the washer can deliver a high pressure spray that can break glass and gouge soft wood and other materials.

When cleaning building interiors or exteriors without detergents, work from top to bottom. This will help eliminate streaks. In interiors, start with the ceiling first, then the walls and the floor last.

CAUTION! Clean around windows carefully. If glass panes are not well-caulked and puttied, the high pressure spray could break the glass.

CAUTION: Never spray directly overhead. Always spray ahead to avoid dripping or falling debris.

Removing Paint

IMPORTANT: Remember that high pressure spray can gouge soft woods and other materials, as well as loosen grout.

1. Direct spray at a 45° angle about 4 to 12 inches (10 to 30cm) from surface.
2. Spray in a back and forth motion, try to get beneath the loose and bubbled paint.
3. Do not be concerned with the paint that remains. It should be sufficiently bonded so as not to cause repainting problems.