



EZITIG 205 AC/DC INVERTER WELDER

OPERATING INSTRUCTIONS



🔑 IMPORTANT!

To qualify for full 24 month warranty, you must register within 30 days of purchase. See inside for details.

Read these Operating Instructions Completely before attempting to use this machine. Save this manual and keep it handy for quick reference. Pay particular attention to the safety instructions we have provided for your protection. Contact your distributor if you do not fully understand anything in this manual.



230V 50HZ
SINGLE
PHASE



IGBT
INVERTER
TECHNOLOGY



DIRECT
CURRENT
OUTPUT



CONSTANT
CURRENT/
VOLTAGE



SPIKE/
GENERATOR
SAFE



INTELLIGENT
PROTECTION
SYSTEM



IP23 CORROSION
& SALT SPRAY
RESISTANT



EZITIG 205 AC/DC

Congratulations & thank you for choosing STRATA!

Strata provides market leading value, features and durability. STRATA machines have been designed with emphasis on robust construction, with simple and functional operation.

Register Your Warranty Now

Standard warranty without registration is 12 months.

To qualify for an extended full 24 month warranty on your purchase you must register within 30 days of purchase.

You will need;

- a) A copy of your purchase invoice / receipt.
- b) Your machine serial number which can be found on the technical data plate on the back of the machine, or on the outside of the box that your machine came in.



1 CONTENTS

1	CONTENTS.....	3
2	BASIC SPECIFICATIONS	7
3	KNOW YOUR MACHINE.....	8
3.1	Machine Front.....	8
3.2	Machine Rear	8
3.3	Control Panel.....	9
3.4	LCD Readout.....	10
3.5	Arc Parameter Chart.....	10
3.6	TIG Torch Controls	11
3.7	Symbols chart.....	12
4	CONTROLS EXPLAINED.....	13
4.1	Weld Process Selection	13
4.1.1	STICK.....	13
4.1.2	HF TIG.....	13
4.1.3	LIFT TIG.....	13
4.2	Output Current Mode Selection.....	14
4.2.1	DC (Direct Current).....	14
4.2.2	AC (Alternating Current).....	14
4.3	Function Selection.....	15
4.3.1	Spot Weld Function.....	15
4.3.2	Pulse Welding Function.....	15
4.3.3	Normal Welding Function / Off.....	15
4.4	Trigger Mode Selection	16
4.4.1	2T (Standard Trigger).....	16
4.4.2	4T (Latch Trigger).....	16
4.5	TIG Arc Parameters/Characteristics Settings.....	16
4.5.1	Pre-Flow Time / PRE GAS (36).....	17
4.5.2	Start Current / START AMPS (37).....	17
4.5.3	Slope Up / UP SLOPE (38).....	17
4.5.4	Trough Current / TROUGH AMPS (39).....	17
4.5.5	Pulse Wave Width / WIDTH (41).....	17
4.5.6	Pulse Wave Frequency / FREQUENCY (40).....	17
4.5.7	Base/Peak Current / BASE/PEAK AMP (42).....	17
4.5.8	Slope Down / DOWN SLOPE (44).....	17
4.5.9	End Current / FINISH AMPS (45).....	17
4.5.10	Post Flow / POST GAS (46).....	17
4.5.11	Clean Width Area / AC BALANCE (43).....	18



EZITIG 205 AC/DC

4.6	Remote Controls.....	18
4.6.1	Remote Control TIG Torch	18
4.6.1	Remote Foot Control (Optional Accessory).....	18
4.7	MMA/Stick Arc Parameters/Characteristics Settings	19
4.7.1	Current / Amps (33)	19
4.7.2	Hot Start Adjustment (34).....	19
4.7.3	Arc Force Adjustment (Stick).....	19
4.8	LCD Multi-Function Display (26).....	20
4.9	Error/Over Temperature Indicator Light.....	20
5	POWER SUPPLY	22
5.1	Electrical Connection.....	22
5.2	Extension Leads.....	22
5.3	Generator Use	22
5.3.1	Generator Size.....	22
5.3.2	Generator Quality & Warranty Limitations	22
5.3.3	3 Golden Rules of Generator use	22
6	OPERATING ENVIRONMENT.....	23
6.1	Location.....	23
6.2	Ventilation	23
7	BASIC SETUP.....	24
7.1	Stick (MMA) Welding Setup	24
7.2	TIG Welding Setup.....	25
8	ACCESSORIES, SPARE PARTS & CIRCUIT DIAGRAMS.....	26
8.1	TIG Torch and Spares:.....	26
8.2	Optional Accessories	27
9	CARE & MAINTENANCE.....	28
9.1	Keep your Welding Machine in Top Condition	28
9.2	Storing the Welder	28
10	GENERAL GUIDE TO WELDING	29
10.1	Duty Cycle Rating	29
10.2	Choosing a Welding Process – MMA/Stick or TIG?	29
10.2.1	The Stick (MMA) Process	29
10.2.2	The TIG Process.....	30
10.3	Joint Preparations.....	31
11	STICK (MMA) BASIC WELDING GUIDE	33
11.1	Size of Electrodes	33
11.2	Storage of Electrodes	33



EZITIG 205 AC/DC

11.3	Electrode Polarity	33
11.4	Effects of Stick (MMA) Welding on Various Materials.....	33
11.4.1	High Tensile and Alloy Steels.....	33
11.4.2	Manganese Steels	33
11.4.3	Cast Iron	33
11.5	Types of Electrodes	34
11.5.1	Mild Steel	34
11.5.2	Cast Iron	34
11.5.3	Stainless Steel	34
11.6	Suggested Settings for Typical Stick (MMA) Applications	34
11.7	MMA Welding Techniques	35
11.7.1	A Word for Beginners.....	35
11.7.2	The Welder.....	35
11.7.3	Striking the Arc.....	35
11.7.4	Arc Length	36
11.7.5	Rate of Travel	36
11.8	Making Welded Joints	37
11.8.1	Butt Welds.....	37
11.8.2	Fillet Welds.....	38
11.8.3	Vertical Welds	39
11.8.4	Overhead Welds.....	40
11.9	MMA (Stick) Troubleshooting.....	41
12	TIG BASIC WELDING GUIDE	43
12.1	TIG Electrode Selection and Preparation	43
12.1.1	Tungsten Electrode Selection & Polarity	43
12.1.2	Preparing Tungsten	44
12.1.3	Shielding Gas for TIG Welding.....	45
12.1.4	Typical TIG Welding Settings	45
12.2	Starting the Weld	46
12.2.1	Lift-Arc Ignition.....	46
12.2.2	HF Ignition.....	46
12.3	Main Weld Current.....	47
12.3.1	DC Current.....	47
12.3.2	AC Current.....	47
12.3.3	Pulse Welding.....	48
12.3.1	AC Balance	49
12.4	Finishing the Weld.....	50
12.4.1	Down-Slope.....	50
12.4.1	Post Gas Flow	50



EZITIG 205 AC/DC

12.4.1	Finish Current.....	50
12.5	TIG Welding Troubleshooting.....	51
13	KNOWLEDGE & RESOURCES.....	52
14	SAFETY.....	52
14.1	Store and Retain this Manual.....	52
14.2	Important Safety Information.....	52
14.3	Welding Operation.....	52
14.4	Welding Safety Instructions & Warnings.....	54
14.4.1	Personal Safety.....	55
14.4.2	Arc Rays can Burn Eyes and Skin.....	55
14.4.3	Noise Can Damage Hearing.....	55
14.4.4	Work Environment Safety.....	56
14.4.5	Electricity Can Kill.....	56
14.4.6	Fumes And Gases.....	57
14.4.7	Fire & Explosive Risks.....	58
14.4.8	Sparks & Hot Metal.....	58
14.4.9	Gas Cylinders.....	59
15	WARRANTY.....	60



EZITIG 205 AC/DC

2 BASIC SPECIFICATIONS

Description	EZITIG205AC/DC
Part Number	EZITIG 205 AC/DC
Dimensions of Power Source (L x W x H)	455 x 305 x 145mm (including handle)
Weight of Power Source	8.5kg
Standard	AS 60974.1
Power Supply	240V +/- 15% 50hz Single Phase
Factory Fitting Supply Plug Rating	15A
Effective Input Current (I_{1eff})	15A
Maximum Input Current (I_{1max})	32A
Output Terminals	Dinse™ style 35-50
Protection Class	IP23
AC TIG (GTAW) Welding	
Welding Current Output	10 – 200A
Duty Cycle	200A @ 24% 155A @ 60% 120A @ 100%
Nominal Open Circuit Voltage	52V
TIG Tungsten Size	1.6 – 2.4mm
DC TIG (GTAW) Welding	
Welding Current Output	10 – 200A
Duty Cycle	170A@ 29% 110A@100% 140A@ 60%
Nominal Open Circuit Voltage	52V
TIG Tungsten Size	1.6 – 2.4mm
AC Stick (MMA) Welding	
Welding Current Output	10 – 170A
Duty Cycle	170A @ 14% 140A @ 60% 110A @ 100%
Nominal Open Circuit Voltage	52V
MMA Electrode Size	1.6 – 4.0mm
DC Stick (MMA) Welding	
Welding Current Output	10 – 170A
Duty Cycle	170A @ 14% 140A @ 60% 110A @ 100%
Nominal Open Circuit Voltage	52V
MMA Electrode Size	1.6 – 4.0mm

Table 1



3 KNOW YOUR MACHINE

3.1 Machine Front

1. Carry Handle
2. Control panel
3. TIG Torch Gas Connector
4. Negative (-) Welding Power Output Connection Socket
5. TIG torch Interface Connector
6. Positive (+) Welding Power Output Connection Socket

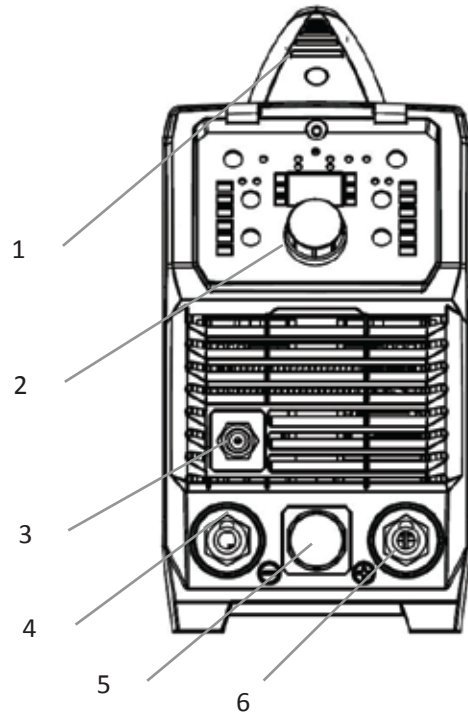

Figure 1

3.2 Machine Rear

7. Mains Power Switch
8. 240V AC Mains Power Input Lead
9. Gas Inlet Connection

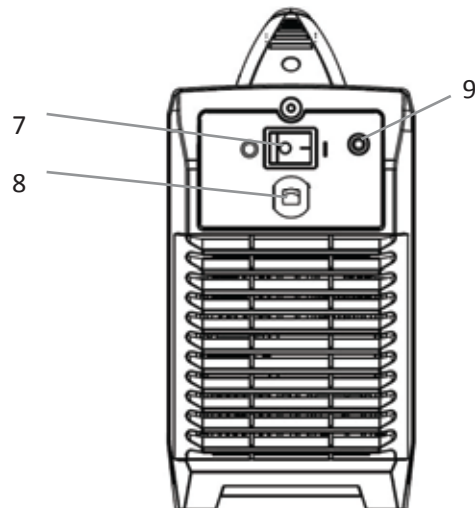

Figure 2



EZITIG 205 AC/DC

3.3 Control Panel

- 10. Power On Indicator Light (POWER)
- 11. Stick (MMA) Process Indicator Light (STICK)
- 12. Process Selection Button (PROCESS)
- 13. High Frequency Start TIG Process Indicator Light (HF TIG)
- 14. Lift Arc Start TIG Process Indicator Light (LIFT TIG)
- 15. Spot Weld Function Indicator Light (SPOT)
- 16. Pulse Arc Function Indicator Light (PULSE)
- 17. Normal Arc Function Indicator Light (NORMAL/OFF)
- 18. Function Selection Button (FUNCTION)
- 19. Selection Knob
- 20. Mode Selection Button (MODE)
- 21. AC Arc Output Mode Indicator Light (AC)
- 22. DC Arc Output Mode Indicator Light (DC)
- 23. Latch Trigger Mode Indicator Light (4T)
- 24. Trigger Mode Selection Button
- 25. Normal Trigger Mode Indicator Light (2T)
- 26. LCD Readout
- 27. Error/Over Temperature Indicator Light
- 28. Arc Parameter Chart

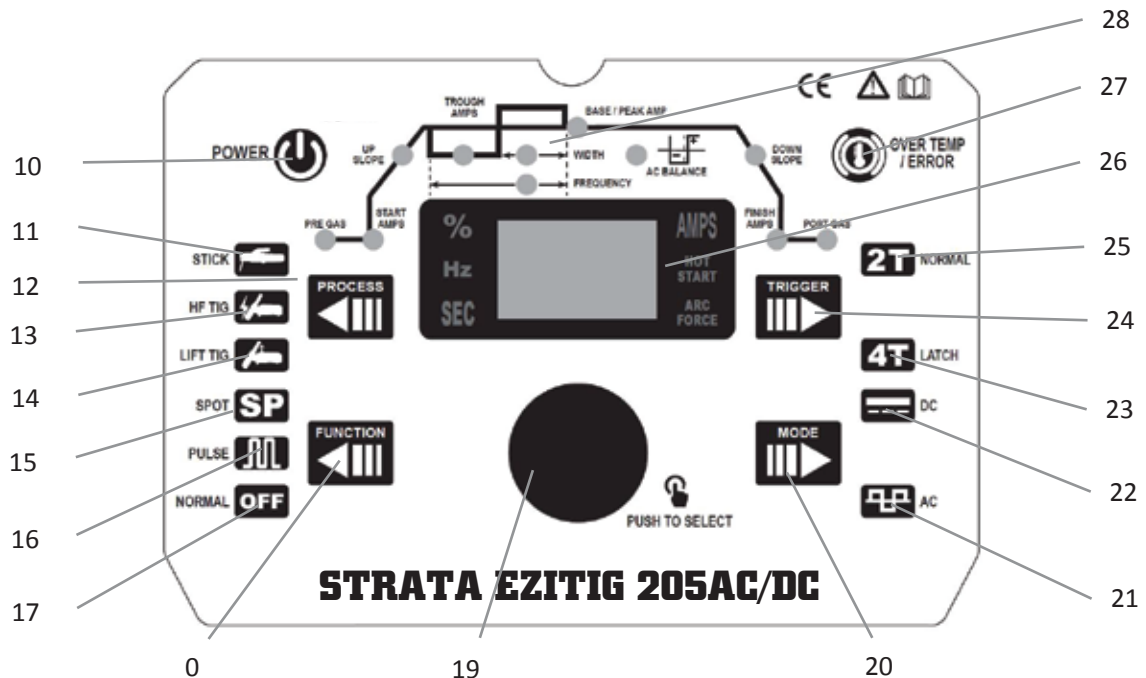

Figure 3

3.4 LCD Readout

- 29. Percentage Setting Indicator Light (%)
- 30. Hertz/Frequency Setting Indicator Light (Hz)
- 31. Time/Seconds Setting Indicator Light (SEC)
- 32. LCD Screen
- 33. Amperage Setting Indicator Light (AMPS)
- 34. Hot Start Setting Indicator Light (HOT START)
- 35. Arc Force Setting Indicator Light (ARC FORCE)

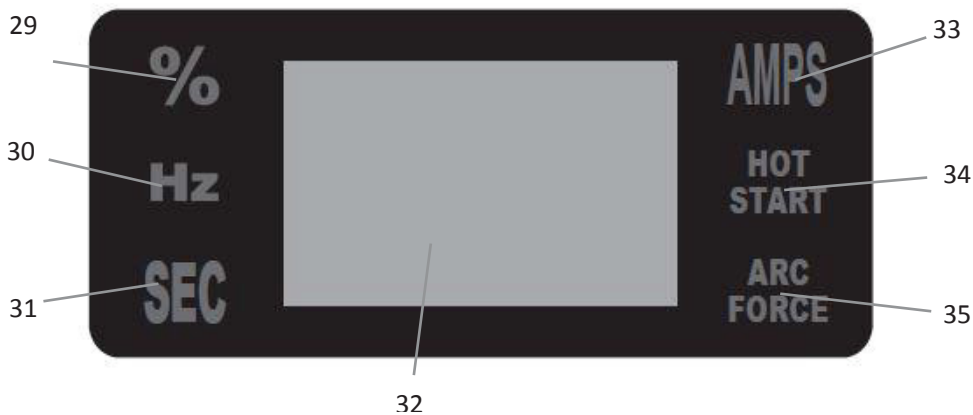

Figure 4

3.5 Arc Parameter Chart

- 36. Pre-Gas Setting Indicator Light (PRE GAS)
- 37. Start Amps Setting Indicator Light (START AMPS)
- 38. Slope-Up Setting Indicator Light (UP SLOPE)
- 39. BASE Current Amps Setting Indicator Light (BASE Current AMPS)
- 40. Pulse Wave Frequency Setting Indicator Light (FREQUENCY)
- 41. Pulse Wave Width Setting Indicator Light (WIDTH)
- 42. Base/Peak Amp Setting Indicator Light (BASE/PEAK AMP)
- 43. AC Arc Balance Setting Indicator Light (AC BALANCE)
- 44. Slope-Down Setting Indicator Light (DOWN SLOPE)
- 45. Finish Amps Setting Indicator Light (FINISH AMPS)
- 46. Post-Gas Setting Indicator Light (POST GAS)

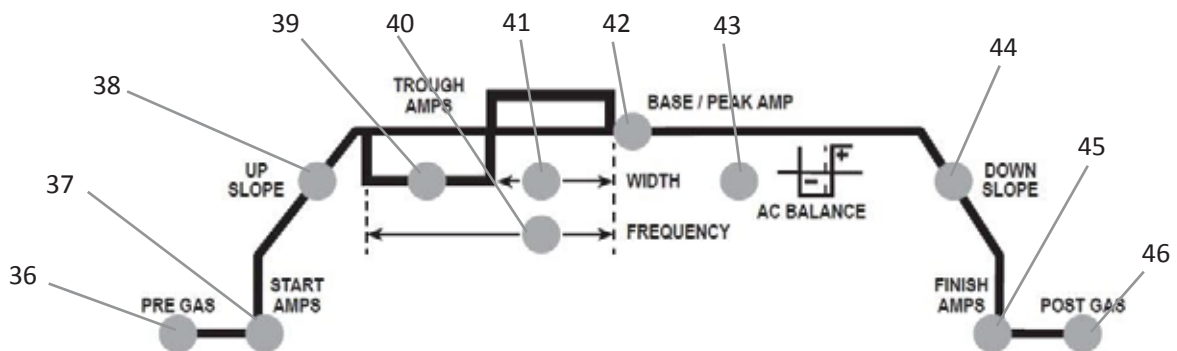

Figure 5



EZITIG 205 AC/DC

3.6 TIG Torch Controls (Optional)

- 47. Torch Trigger Button
- 48. Remote Control Amperage Potentiometer

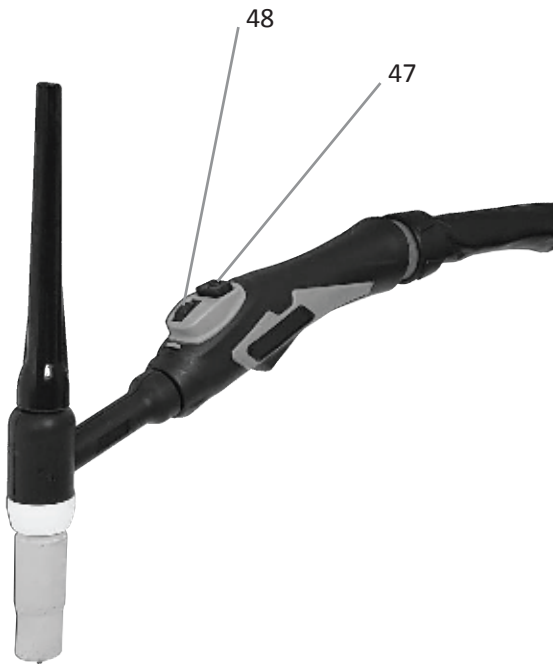

Figure 6

3.7 Symbols chart

I	Power On
O	Power Off
	Power On Indication
	Fault Indication
	Caution / Hazard
	Read Instruction Manual
	HF TIG Function
	Lift Arc TIG Function
	Stick/MMA Function
SP	Spot Weld Function
	Pulse Function
	Alternating Current (AC)
	Amperage (current) output
	Voltage output
	AC Arc Balance
2T	2T/Normal Trigger Function

4T	4T/Latch Trigger Function
	Single phase Inverter power source AC/DC
	Stick/MMA (SMAW) Function
	TIG (GTAW) Function
	Power Supply Connection
1~	Single Phase
	Alternating Current (AC)
	Direct Current (DC)
-	Negative
+	Positive
Hz	Hertz (cycles/sec)
X	Duty Cycle
A	Amperage (Current)
V	Voltage

Table 2



4 CONTROLS EXPLAINED

4.1 Weld Process Selection

1. Press 'Process' button (12) until the desired Welding Process Indicator Light (11, 13 or 14) is lit.

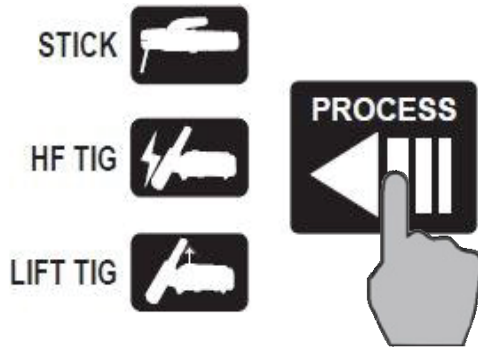

Figure 7

4.1.1 STICK

Stick/MMA welding

4.1.2 HF TIG

High Frequency Start TIG welding. This uses a high frequency arc to start the welding arc which eliminates the need for the tungsten electrode to make contact with the job. This is easier to use and prevents tungsten contamination. The disadvantage of HF ignition is that the high energy electrical pulse creates significant electrical and radio signal interference, which limits its use around sensitive electronic equipment such as some computers and CNC equipment.

See 12.2.2 for more information.

4.1.3 LIFT TIG

Lift Arc Start TIG welding. This requires the tungsten to be briefly touched on the work piece. As the tungsten electrode is lifted back off the work piece the welding arc will be initiated. This does require more skill.

See 12.2.1 for more information.



EZITIG 205 AC/DC

4.2 Output Current Mode Selection

1. Press 'MODE' button (20) until the desired Welding Process Indicator Light (21 or 22) is lit.

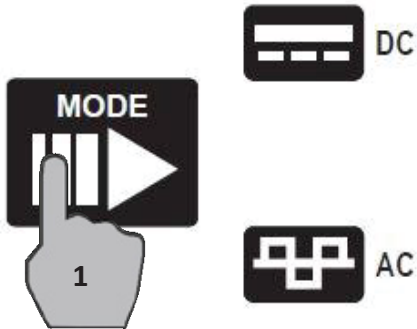

Figure 8

4.2.1 DC (Direct Current)

Direct Current. This is suitable for TIG welding ferrous (iron based) metals such as mild steel and stainless steel, copper and titanium and also suitable for most Stick/MMA welding.

See 12.3.1 for more information.

4.2.2 AC (Alternating Current)

This is required for welding reactive metals such as Aluminium, Magnesium and Zinc. When reactive metals are exposed to air they form an oxide layer that insulates the base metal and prevents welding current flowing, it also contaminates the weld pool. Reverse current flow is required to break through/clean off this oxide layer so that welding can take place, while the current flow during the positive cycle does the majority of the heating of the weld pool area. This is also used for some specialty Stick/MMA welding.

See 12.3.2 for more information.



EZITIG 205 AC/DC

4.3 Function Selection

1. Press 'Function' button (18) until the desired Function Indicator Light (15, 16 or 17) is lit.

NOTE: Functions are only available in TIG mode.

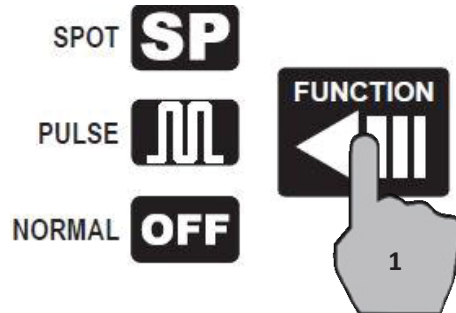

Figure 9

4.3.1 Spot Weld Function

Spot/Stitch Weld Time setting is adjustable from 0 – 10 seconds. This controls the length of time for the weld. When the trigger button is pressed on the TIG torch the machine will weld for the set time and then stop. This is great for producing very precise weld size or ensuring consistent weld size/length when spot welding, tacking or stitch welding.

Spot Weld function is only available for HF TIG process and with DC Output.

4.3.2 Pulse Welding Function

Pulse welding mode switches the welding output between a high and low current output in a cyclical manner. When used correctly this function has substantial benefits in the TIG welding process including greater weld penetration for less work heat input and greater control of the weld pool.

The basic theory for setting the base current using pulse mode is that the trough current should be sufficient to maintain the existing molten weld pool, while the peak current is sufficient to melt new metal in order to move/expand the molten weld pool. Increased pulse frequency will have the effect of making the arc more tightly focused which is useful for fine stainless work and similar.

Pulsing can also be used to help move the weld pool, this technique is useful for welding out of position or with materials that have higher viscosity weld pool. Higher pulse duty setting will give greater heat input, while lower pulse duty will have the opposite effect.

See 12.3.3 for more information.

4.3.3 Normal Welding Function / Off

This is standard non-pulse welding mode.



EZITIG 205 AC/DC

4.4 Trigger Mode Selection

1. Press 'Trigger' button (24) until the desired Trigger Mode Light (23 or 25) is lit.

NOTE: Trigger mode selection only applies to TIG welding and is also disabled when the 'Spot' function is turned on.

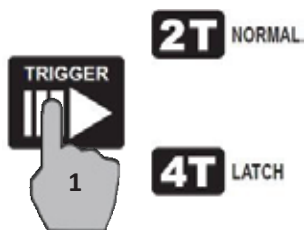

Figure 10

4.4.1 2T (Standard Trigger)

2T stands for Two Touch or 'Standard Trigger' mode. In this mode the trigger button is pressed and held on to start welding, when the trigger button is released, the welding stops.

4.4.2 4T (Latch Trigger)

4T stands for Four Touch or 'Latching' mode. The trigger button is pressed once and released to start welding and then pulled and released again to stop the welding. This function is useful for longer welds as the trigger is not required to be held on continuously and thus reduced operator fatigue.

4.5 TIG Arc Parameters/Characteristics Settings

NOTE: The following parameter settings are only available in TIG welding modes.

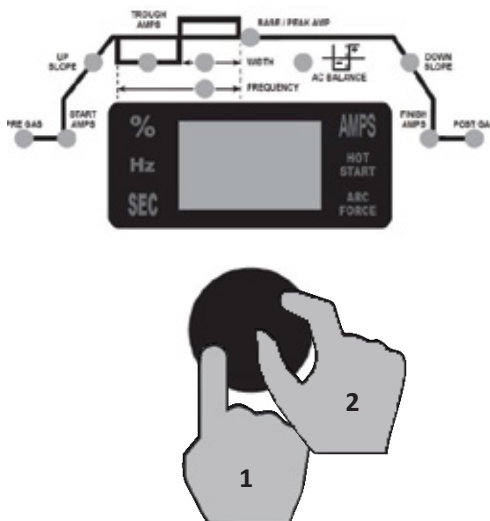

Figure 11

1. Press 'Selection' knob down (19) until the desired Arc Parameter Setting Indicator Light (36 - 46) is lit.
2. Rotate the 'Selection' knob to adjust the Setting



EZITIG 205 AC/DC

4.5.1 Pre-Flow Time / PRE GAS (36)

Pre-Gas (or Pre-Flow) setting is adjustable from 0 – 2 seconds. This controls the period of time the shielding gas will flow when the torch is triggered before the arc starts. This purges the weld area from atmospheric gas which could contaminate the start of the weld.

4.5.2 Start Current / START AMPS (37)

Available in 4T trigger mode only. This sets a welding current activated when the torch trigger button is held on at the start of the weld. Once the trigger is released, the current will go through the upslope (38) period if it is set, to the main welding current.

4.5.3 Slope Up / UP SLOPE (38)

Up Slope setting is adjustable from 0 – 10 seconds. When the trigger is activated, the welding current will increase gradually over the time selected up to the main welding current.

4.5.4 Trough Current / TROUGH AMPS (39) (BASE Current)

Available in Pulse mode only. This sets the level of the low/trough current of the pulse.

4.5.5 Pulse Wave Width / WIDTH (41)

When in Pulse mode: Sets the time proportion as a percentage between the peak current and trough current. Neutral setting is 50% and the time period of the peak current and base current pulse is equal. Higher pulse duty setting will give greater heat input, while lower pulse duty will have the opposite effect. *See 12.3.3 for more information.*

When in Spot mode: Sets the portion of the weld cycle that is spent welding. For example if cycle time is set to 10sec and with is 20% then the machine will weld for 2secs and pause for 8secs.

4.5.6 Pulse Wave Frequency / FREQUENCY (40)

Available in Pulse mode only. This sets the rate that the welding output alternates between the peak and trough current settings. *See 12.3.3 for more information.*

4.5.7 Base/Peak Current / BASE/PEAK AMP (42)

When in Normal or Spot function this is the main welding current setting.

In Pulse mode this is the high/peak current of the pulse. *See 12.3.3 for more information.*

4.5.8 Slope Down / DOWN SLOPE (44)

Slope-Down time setting is adjustable from 0 – 10 seconds. When the trigger is released, the welding current will reduce gradually over the time selected down to 0. This allows the operator to complete the weld without leaving a 'crater' at the end of the weld pool.

4.5.9 End Current / FINISH AMPS (45)

Available in 4T trigger mode only, sets a welding current that is activated when the trigger is held on at the end of the weld (to 'unlatch' the trigger before the weld is finished). If downslope (44) is set, the current will go through the downslope period before going to the End Current setting. When the trigger is released, the arc will stop.

4.5.10 Post Flow / POST GAS (46)

Controls the period of time the shielding gas continues to flow for after the arc is stopped. This protects the weld area and torch tungsten from contamination while it is still hot enough to react with atmospheric gases, after the weld is finished.



EZITIG 205 AC/DC

4.5.11 Clean Width Area / AC BALANCE (43)

Adjusts the balance as a percentage between the forward and reverse current cycles when welding in AC output mode. The reverse part of the AC cycle gives the 'cleaning' effect on the weld material, while the forward cycle melts the weld material. Neutral setting is 0.

Increased reverse cycle bias will give greater cleaning effect, less weld penetration and more heat in the torch tungsten. This gives the disadvantage of reducing the output current that can be used for a given tungsten size to prevent the tungsten overheating.

Increased forward cycle bias will give the opposite effect, less cleaning effect, greater weld penetration and less heat in the tungsten.

Ideally for maximum effectiveness, the clean width/ AC balance should be set with as much forward cycle bias as possible, while still maintaining a sufficient level of oxidisation removal for a contamination free weld pool. The cleaner the non-ferrous metal is before welding, the more effective it is to weld. This effect can also be used to reduce heat in the tungsten, allowing use of a pointed tungsten tip shape for a more defined arc. *See 12.3.1 for more information.*

4.6 Remote Controls

4.6.1 Remote Control TIG Torch (Optional Accessory)

The TIG torch for the EZITIG205AC/DC machine incorporates a Remote Control Amperage Potentiometer on the handle (48). This can be used to change the Base/Peak current either before or during welding.

4.6.1 Remote Foot Control (Optional Accessory)

An optional Foot control is available for use with the EZITIG205AC/DC machine.

1. Plug into the Torch Control Interface connection (5) instead of the interface plug on the TIG torch.
2. Set the Trigger Mode to 2T (Refer to 4.4)
3. Set Function to Normal (Refer to 4.3)

On this Foot control the first stage of the foot movement activates the 'Trigger' function. You will hear the foot control 'click' at this point.

After this point the rest of the foot movement regulates the Base Current output.

The Adjustment knob on the Foot control calibrates the maximum Base Current (as a portion of the base current set on the machine) that is represented when the Foot Pedal is right down.

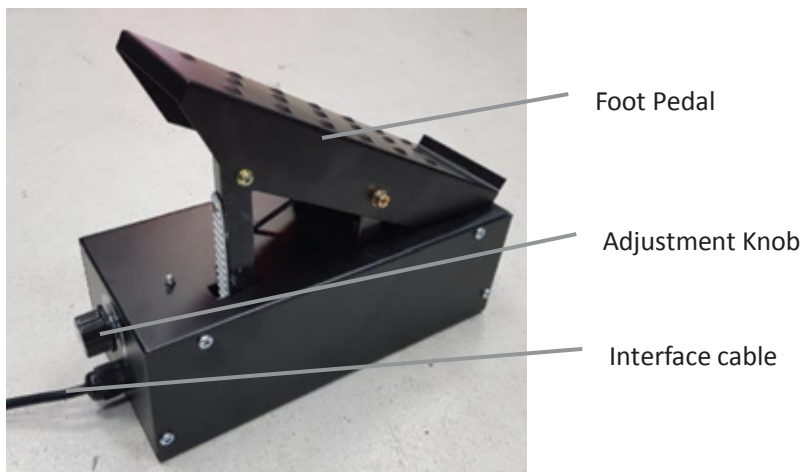

Figure 12



EZITIG 205 AC/DC

4.7 MMA/Stick Arc Parameters/Characteristics Settings

NOTE: The following parameter settings are only available in MMA/Stick welding mode.

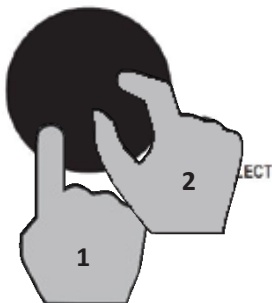

Figure 13

1. Press 'Selection' knob down (19) until the desired Arc Parameter Setting Indicator Light (33,34 or 35) is lit.
2. Rotate the 'Selection' knob to adjust the Setting

4.7.1 Current / Amps (33)

This is the main welding current.

4.7.2 Hot Start Adjustment (34)

Hot Start setting is adjustable from 0 – 100%. Hot start provides extra power when the weld starts to counteract the high resistance of the electrode and workpiece as the arc is started. It makes igniting the electrode easier and prevents it from sticking when cold.

4.7.3 Arc Force Adjustment (Stick)

Arc Force setting is adjustable from 0 – 100%. Sometimes called 'Dig' or 'Arc Control'. A Stick welder is designed to produce constant output current (CC). This means with different types of electrode and arc length; the welding voltage varies to keep the current constant. This can cause instability in some welding conditions as Stick welding electrodes will have a minimum voltage they can operate with and still have a stable arc.

Arc Force control boosts the welding power if it senses the welding voltage is getting too low. The higher the arc force adjustment, the higher the minimum voltage that the power source will allow. This effect will also cause the welding current to increase. 0 is Arc Force off, 100 is maximum Arc Force. This is practically useful for electrode types that have a higher operating voltage requirement or joint types that require a short arc length such as out of position welds.



EZITIG 205 AC/DC

4.8 LCD Multi-Function Display (26)

When welding is not in progress the LCD Readout (26) displays the setting selected/being adjusted using the Selection Knob (19).

During welding the LCD Readout (26) displays the actual welding current.

The parameter setting displayed is indicated by the LEDs beside the display:

- **SEC:** Time (31)
- **%:** Percentage (29)
- **Hz:** Frequency (30)
- **AMPS:** Current/Amperage (33)

If left inactive for several seconds, display will revert back to main welding current setting.

Also displays error codes if the protection system (27) is activated.

4.9 Error/Over Temperature Indicator Light

Error/Over Temperature Indicator Light (30) illuminates when duty cycle is exceeded and thermal protection is activated. When thermal protection is activated, welding output will be disabled until machines cools sufficiently and overload indicator lamp goes out.

This may also activate if there are electronic circuit failure issues.



Figure 14

When there is an error the LCD screen will display an error code to indicate what the error is. Refer to the following table for error code explanations.

Code	Error	Solution
E01 – E09	The machine has exceeded its safe temperature or duty cycle.	Ensure the cooling fan is working. If not, contact supplier. Wait for machine to cool down.
E13	Input voltage has fallen below safe tolerance level.	Check the voltage of your power supply.
E14	Input voltage has risen above safe tolerance level.	Check the voltage of your power supply.
E15	Excessive current through IGBT electronics due to machine misuse or technical fault.	Ensure usage of machine is in line with guidelines in this manual.



EZITIG 205 AC/DC

Code	Error	Solution
E20	Button/Control system error on Control Panel during start-up	Try turning machine off for 10 seconds and the back on.
E21	Button/Control system error during start-up (not on Control Panel)	Try turning machine off for 10 seconds and the back on.
E22	Welding torch error during start-up	Try turning machine off for 10 seconds and the back on.
E23	Welding torch error during welding	Ensure torch is connected correctly. Disconnect & reconnect welding torch. Replaced welding torch.

Table 3

If you are unable to resolve the error by restarting the machine or with any of the above solutions, contact your Strata distributor to arrange to have the machine assessed by a technician.



5 POWER SUPPLY

5.1 Electrical Connection

The EZITIG205AC/DC is designed to operate on a 15A 240V AC power supply.

5.2 Extension Leads

If an extension cord must be used, it should be minimum cable core size or 2.5mm².

Using extension leads of over 20m is not recommended.

5.3 Generator Use

This machine is designed with generator use in mind and incorporates wide voltage tolerance and intelligent voltage sensing technology to provide maximum protection from power fluctuations that can occur with motor generators.

5.3.1 Generator Size

Generator size should be not less than 8kva. An 10kVa generator will not provide enough power to enable full output and duty of this welder. However, it should provide sufficient power to enable TIG welding up to approximately 160A or Stick/MMA welding up to approximately 140A. To enable full output and duty cycle of this welder, minimum recommended generator size is 10kVa.

5.3.2 Generator Quality & Warranty Limitations

Avoid using poor, low quality generators as these have the greatest risk of power spikes etc. A suitable quality generator should have a THD (total harmonic distortion) rating of no more than 6%. Most reputable generator suppliers will be able to specify the THD ratings on their product. Any damage caused by poor quality generator power supply or incorrect use is not covered under warranty.

5.3.3 3 Golden Rules of Generator use

When running an inverter welder off a generator there are 3 **VERY IMPORTANT** Golden Rules that **MUST** be followed:

1. Do **NOT** plug welder into generator until **AFTER** generator has been started up and is running smoothly
2. **UNPLUG** welder from generator **BEFORE** shutting generator down/turning generator off
3. **NEVER** let your generator run out of fuel whilst the welder is plugged in.

Following these Golden Rules will significantly reduce the risk of any damage resulting from generator power supply.



6 OPERATING ENVIRONMENT

6.1 Location

The machine has electrical components and control circuit boards which may be damaged by excessive moisture, dust and dirt, so a clean and dry operating environment is important for reliable product life.

Environments hotter than 40°C or with humidity greater than 90% should be avoided.

The enclosure design of this power source meets the requirements of IP23S as outlined in AS60529. This provides adequate protection against solid objects (greater than 12mm), and direct protection from vertical drops. Under no circumstances should the unit be operated or connected in a micro environment that will exceed the stated conditions. For further information please refer to AS 60529.

6.2 Ventilation

Adequate ventilation is required to provide proper cooling for the machine. Ensure that the machine is placed on a stable level surface where clean cool air can easily flow through the unit.



7 BASIC SETUP

7.1 Stick (MMA) Welding Setup

1. Connect the earth cable quick connector to the Negative (-) Welding Power Output Socket (4)
2. Connect the earth clamp to the work piece. Contact with the work piece must be firm contact with clean, bare metal, with no corrosion, paint or scale at the contact point.
3. Insert an electrode into the electrode holder and connect the electrode holder and work lead to the Positive (+) Welding Power Output Socket (6).

NOTE: This polarity connection configuration is valid for most GP (General Purpose) MMA electrodes. There are variances to this. If in doubt, check the electrode specifications or consult the electrode manufacturer.

4. Connect the machine to suitable power. Switch the mains power switch (7) to 'on' to power up the machine.
5. Set welding process selector to 'Stick' (refer to 4.1)
6. Select the required output current using the Selection Knob (19). The LCD Readout (26) will display the set amperage output.
7. Adjust special Function settings if required (refer to 4.7)
8. You are now ready to weld!

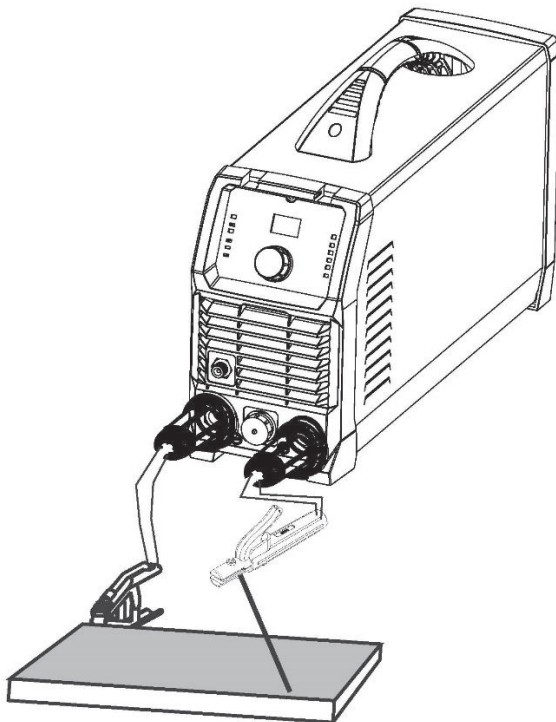

Figure 15



EZITIG 205 AC/DC

7.2 TIG Welding Setup

1. Connect the earth cable to the Positive (+) Welding Power Output Socket (6)
2. Connect the earth clamp to the work piece. Contact with the work piece must be firm contact with clean, bare metal, with no corrosion, paint or scale at the contact point.
3. Insert TIG torch power connection into the Negative (-) Welding Power Output Socket (4)
4. Connect TIG multi-pin connector to the TIG Torch Interface socket (5)
5. Connect TIG torch gas line to the TIG Torch Gas Connection (3) on the front of the machine. Ensure all connections are tight.
6. Assemble the female gas fitting to the gas hose securing it with the hose clamp provided.
7. Screw the female gas fitting onto the regulator outlet fitting.
8. Connect the gas regulator to a gas cylinder (not included with machine)
9. Connect the gas hose to the Gas Inlet Connection tail (9) on the rear of the machine securing it with the hose clamp provided.
10. Ensure all connections are tight.
11. Open gas cylinder valve carefully
12. Adjust regulator. Flow should be between 5-10 l/min depending on application. Re-check regulator flow pressure with the torch triggered as static gas flow setting may drop once gas is flowing.
13. Connect the machine to suitable power. Switch the mains power switch (7) to 'I' to power up the machine.
14. Set welding process selector to the desired TIG Process Mode (refer to 4.1)
15. Select desired Output Current Mode (refer to 4.2)
16. Select desired Trigger Mode (refer to 4.4)
17. Select desired Welding Function settings (refer to 4.3)
18. Set the required Arc Parameters using the Selection Knob (19). (Refer to 4.5)
19. You are now ready to weld!

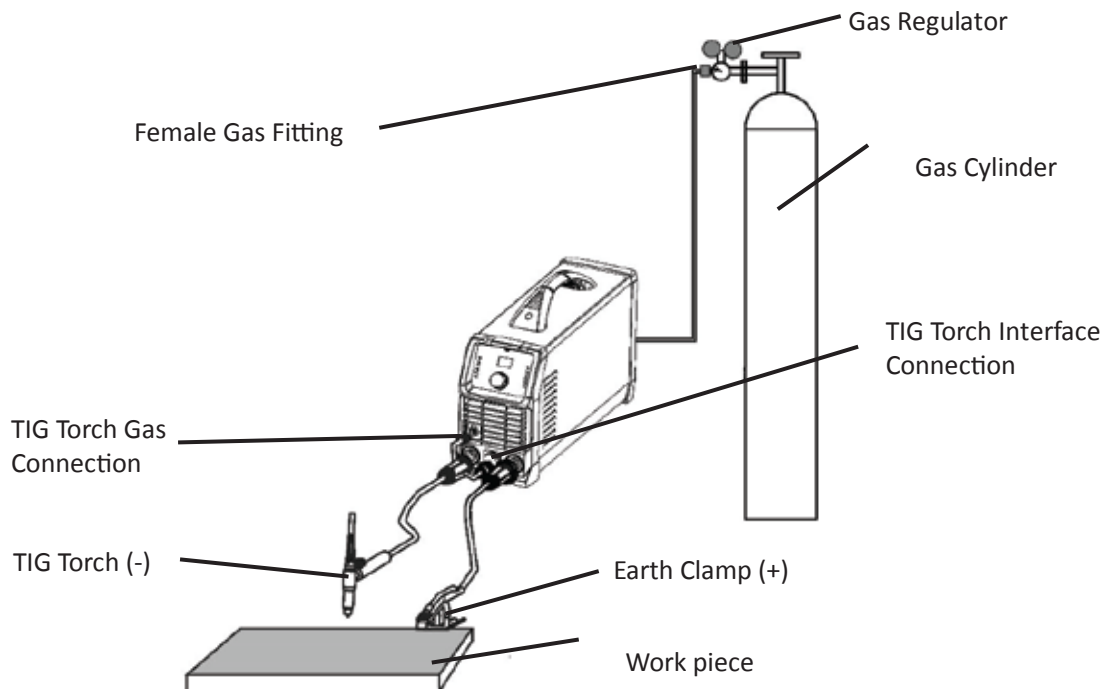

Figure 16



8 ACCESSORIES, SPARE PARTS & CIRCUIT DIAGRAMS

8.1 TIG Torch and Spares:

The compatible TIG torch for this machine is the Strata torch.
 To view this torch and parts, go to: strata.co.nz



Part No.	Description
TER26-12-2VA	Complete TIG Torch – Remote Control 200A 4m
TBWP26	Torch Body - 17 Standard (No Valve)
TBWP26F	Torch Body - 17F Flexible (No Valve)
TCB57Y02	Back cap – Long Pk2
	Back cap – Medium Pk2
TCB57Y04	Back cap – Short Pk2
TC10N23	Collet – 1.6mm
TC10N24	Collet – 2.4mm
TC10N25	Collet – 3.2mm
TCB10N31	Collect Body – 1.6mm Pk2
TCB10N32	Collect Body – 2.4mm Pk2
TCB10N28	Collect Body – 3.2mm Pk2
TCB10N44	TIG Ceramic Cup - #5 7.9mm Pk2
TCB10N48	TIG Ceramic Cup - #6 9.5mm Pk2
TCB10N47	TIG Ceramic Cup - #7 11.1mm Pk2
TCB10N46	TIG Ceramic Cup - #8 12.7mm Pk2
TCB10N45	TIG Ceramic Cup - #10 15.8mm Pk2

Table 4



Figure 17



EZITIG 205 AC/DC

8.2 Optional Accessories

Optional Accessories	
Part No.	
	Welding Trolley
	TIG Gloves
	Welding Gloves
	Remote Foot Control

Table 5



9 CARE & MAINTENANCE

9.1 Keep your Welding Machine in Top Condition

The EZITIG205AC/DC does not require any special maintenance, however the user should take care of the machine as follows:

1. Regularly clean the ventilation slots
2. Keep the casing clean
3. Check all cables before use
4. Check electrode holders, work lead/clamps and welding torches before use
5. Replace worn electrode holders and earth clamps, which do not provide a good connection
6. Replace worn torch consumable parts in a timely manner
7. Replace worn wire drive components in a timely manner
8. Use a soft cloth or brush to clean electrical components. Do not use liquid cleaning products, water or especially solvents
9. Do not use compressed air to clean electrical components as this can force dirt and dust further into components, causing electrical short circuits
10. Check for damaged parts

WARNING! Before performing cleaning/maintenance, replacing cables/connections, make sure the welding machine is switched off and disconnected from the power supply.

If damaged, before further use, the welder must be carefully checked by a qualified person to determine that it will operate properly. Check for breakage of parts, mountings and other conditions that may affect its operation.

Have your welder repaired by an expert. An authorised service centre should properly repair a damaged part.

This appliance is manufactured in accordance with relevant safety standards. Only experts must carry out repairing of electrical appliances, otherwise considerable danger for the user may result. Use only genuine replacement parts. Do not use modified or non-genuine parts.

9.2 Storing the Welder

When not in use the welder should be stored in the dry, dust-free and frost-free environment.



10 GENERAL GUIDE TO WELDING

10.1 Duty Cycle Rating

Strata welding machines are fitted with thermal overload protection which means the machine will cut out when it reaches a certain temperature, to prevent damage to components. The machine will then re-start when it returns to a safe temperature.

Duty cycle is a measure of the percentage of time a machine will operate within a certain time period at a given amperage. For example a duty cycle of 160A @ 25% means that a machine will operate at 160A for 2 ½ minutes in a 10 minute time period. The machine will have to rest for the remaining 7 ½ minutes to enable it to cool down.

The international standard for duty cycle rating is based on an ambient air temperature of 40°C with 50% humidity, over a 10 minute period. In an environment with temperatures exceeding 40°C, the duty cycle will be less than stated. In ambient temperature less than 40°C, duty cycle performance will be higher. There are numerous other factors that can influence actual duty cycle performance.

10.2 Choosing a Welding Process – MMA/Stick or TIG?

10.2.1 The Stick (MMA) Process

10.2.1.1 Description

The acronym MMA (or MMAW) stands for Manual Metal Arc Welding. 'Manual' refers to the fact that the MMA process requires the operator to apply filler metal (in contrast to MIG 'semi-automatic' welding where the machine feeds the filler metal into the weld). 'Metal' refers to the fact that the filler metal itself (the stick electrode) is used to conduct the welding current to the job. MMA welding is commonly known as 'stick-electrode' or 'arc' welding.

10.2.1.2 Process

The MMA process involves the electrode being touched on the job to ignite the arc. The electrode is held in the electrode holder and must be continually replaced as it is consumed. The electrode consists of a metal core, which is the filler metal, covered by a flux coating which shields the weld and prevents it from oxidising. During welding the flux forms into a slag covering the weld which is chipped off after the weld has formed.

10.2.1.3 Advantages

MMA welding offers several advantages over alternative welding processes. Primarily it has a greater capacity than MIG welding, or in other words it can weld heavier materials with the same amperage output. For this reason small, portable inverter welders like the Strata machines, have the capacity to weld with up to 3.2mm or 4mm electrodes making it suitable for a vast range of applications without the complication of shielding gas or wire feeding. Moreover, MMA welding is typically more 'forgiving' than MIG or TIG when welding rusty or dirty materials (which makes it ideal for maintenance applications).

10.2.1.4 Limitations

Traditionally, welding thin materials whilst avoiding "blow-through" can be tricky with the MMA process. This being said, however, welding thin materials with a WeldForce machine will be noticeably easier because the arc is so stable and the output can be very finely adjusted down to very low amps.

10.2.1.5 Materials

MMA welding can be used with a wide variety of electrodes including general purpose, low hydrogen, stainless steel, iron powder, hard facing & cast iron just to name a few.



EZITIG 205 AC/DC

10.2.2 The TIG Process

10.2.2.1 Description

The acronym TIG stands for Tungsten Inert Gas. Tungsten refers to the type of conductor (a tungsten electrode) that is used to transfer the welding current to the job and create the arc. Inert Gas refers to the fact that the process relies on an inert gas to prevent weld oxidation.

Also referred to as Gas Tungsten Arc Welding (GTAW).

10.2.2.2 Process

In simple terms, TIG welding is probably most similar to oxy flame welding. However, instead of a flame it uses an electrical arc to melt the job and filler metal, and instead of a preheat flame it uses inert gas to prevent weld oxidation. Like oxy flame welding, the filler metal is fed into the weld by hand as required. Due to the fact that the current is not conducted to the job via the filler metal, (as it is in MIG and MMA welding), the arc is much more controllable.

10.2.2.3 Advantages

Very low amperages can be achieved making this process ideal for welding thin materials. Also, due to the independence of the arc and the filler metal application, TIG welding is very controllable and can therefore achieve very high quality welds with excellent appearance. Unlike MIG and MMA welding, TIG welding does not produce spatter so clean up is very minimal. It is typically used where weld appearance is critical (e.g. handrails) or where weld quality is vital (e.g. pressure vessels or pipes).

10.2.2.4 Limitations

Whilst TIG welding is very controllable, it can also be slower and more tedious than MIG or MMA welding and it will generally not operate well on dirty or rusty materials meaning that additional weld preparation is sometimes necessary. It also requires a higher level of skill and experience to achieve a quality result.

10.2.2.5 Materials

This machine incorporates AC/DC TIG function which can be used to weld a variety of materials including mild steels, stainless steels, copper and chrome moly, aluminium, titanium and zinc.

10.3 Joint Preparations

In many cases, it will be possible to weld steel sections without any special preparation. For heavier sections and for repair work on castings, etc., it will be necessary to cut or grind an angle between the pieces being joined to ensure proper penetration of the weld metal and to produce sound joints. In general, surfaces being welded should be clean and free of rust, scale, dirt, grease, etc. Slag should be removed from oxy-cut surfaces. Typical joint designs are shown in the following figures.

Open Square Butt Joint



Gap varies from 1.6mm (1/16") to 4.8mm (3/16") depending on plate thickness

Figure 20

Single Vee Butt Joint

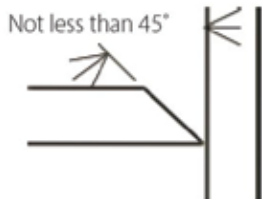

Figure 21

Single Vee Butt Joint

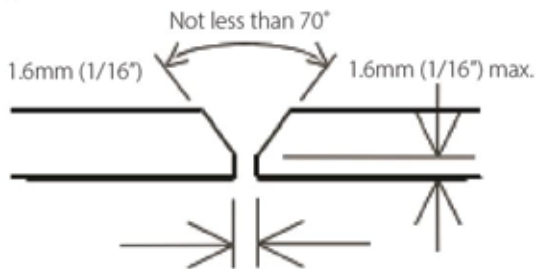

Figure 22

Double Vee Butt Joint

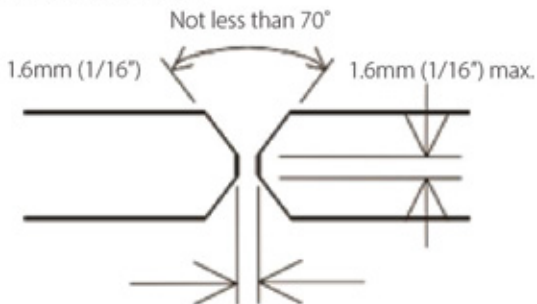

Figure 23

Lap Joint



Figure 24

Fillet Joint



Figure 25

Tee Joints



Figure 26

Edge Joint

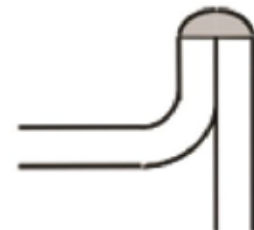

Figure 27

Corner Weld



Figure 28



EZITIG 205 AC/DC

Plug Welds



Figure 29



11 STICK (MMA) BASIC WELDING GUIDE

11.1 Size of Electrodes

The electrode size is determined by the thickness of metals being joined and can also be governed by the type of welding machine available. Small welding machines will only provide current (amperage) to run smaller sized electrodes. For thin sections, it is necessary to use smaller electrodes otherwise the arc may burn holes through the job. A little practice will soon establish the most suitable electrode for a given application.

11.2 Storage of Electrodes

Always store electrodes in a dry place and in their original containers. If electrodes have been exposed to moisture or moist air then they will need to be dried out using an electrode drying oven.

11.3 Electrode Polarity

Electrodes are generally connected to the electrode holder with the electrode holder connected positive polarity.

The work lead is connected to the negative polarity and is connected to the work piece. If in doubt consult the electrode data sheet.

If you are Stick welding in AC mode (which may be required with some specialty applications) then it does not matter which connections the electrode holder and earth lead are connected to.

11.4 Effects of Stick (MMA) Welding on Various Materials

11.4.1 High Tensile and Alloy Steels

The two most prominent effects of welding these steels are the formation of a hardened zone in the weld area, and, if suitable precautions are not taken, the occurrence in this zone of under-bead cracks. Hardened zone and under-bead cracks in the weld area may be reduced by using the correct electrodes, preheating, using higher current settings, using larger electrodes sizes, short runs for larger electrode deposits or tempering in a furnace.

11.4.2 Manganese Steels

The effect on manganese steel of slow cooling from high temperatures causes embrittlement. For this reason it is absolutely essential to keep manganese steel cool during welding by quenching after each weld or skip welding to distribute the heat.

11.4.3 Cast Iron

Most types of cast iron, except white iron, are weldable. White iron, because of its extreme brittleness, generally cracks when attempts are made to weld it. Trouble may also be experienced when welding white-heart malleable, due to the porosity caused by gas held in this type of iron.



11.5 Types of Electrodes

Arc Welding electrodes are classified into a number of groups depending on their applications. There are a great number of electrodes used for specialised industrial purposes which are not of particular interest for everyday general work. These include some low hydrogen types for high tensile steel, cellulose types for welding large diameter pipes, etc. The range of electrodes dealt with in this publication will cover the vast majority of applications likely to be encountered; are all easy to use.

11.5.1 Mild Steel

- 1. General Purpose "GP" E6013:** This all-position electrode is used for maintenance and fabrication. Works well on mild steel, galvanized steel, sheet metal, steel tube and RHS. Its soft arc has minimal spatter, moderate penetration and an easy-to-clean slag. Tolerant to dirty / rusty steel & poor fit up. This is the most common type of electrode used for Stick welding.
- 2. Hydrogen Controlled E7016:** A "low-hydrogen" electrode commonly used for mild or high strength steel, where the joint requires higher strength than regular "GP" electrodes, such as highly restrained joints or components subject to higher load stress. Also used as a buffer layer prior to hard facing. All-Positional (except for vertical down), easy striking & smooth running, with low spatter & easy slag removal..

11.5.2 Cast Iron

- 1. Cast Iron Ni-CI (NCI):** Suitable for joining all cast irons (Suitable for mehanite, alloy and malleable cast iron) except white cast iron. Weld positions : flat, horizontal.

11.5.3 Stainless Steel

- 1. Stainless Steel 316L:** Used for welding common 300 series stainless steels such as 301, 302, 304, 304L and 316L. All welding positions, excluding vertical down. Very Smooth Running and Easy to use.
- 2. Universal 312:** Weld-all style electrodes for welding almost any steel or stainless-steel, including dissimilar metals. Weld metal is very crack resistant. Commonly used for repair and maintenance welding of unknown steels. All welding positions excluding vertical down.

11.6 Suggested Settings for Typical Stick (MMA) Applications

Material	Electrode Type	Electrode Size	Amperage Range
Mild Steel	General Purpose (E6013)	2.6mm	60 – 100
		3.2mm	100 – 140
		4.0mm	140 – 190
Mild Steel	Hydrogen Controlled (High Strength) (E7016)	2.5mm	60 – 110
		3.2mm	90 – 140
		4.0mm	130 – 190
Stainless Steel	Stainless Steel 316L	2.6mm	40 – 70
		3.2mm	100 – 150
		4.0mm	135 – 180

Table 7

These settings are a guide only. Actual settings required will depend on plate thickness, operator technique, environment, etc.



11.7 MMA Welding Techniques

11.7.1 A Word for Beginners

For those who have not yet done any welding, the simplest way to commence is to run beads on a piece of scrap plate. Use mild steel plate about 6.0mm thick and a 3.2mm electrode.

Clean any paint, loose scale or grease off the plate and set it firmly on the work bench so that welding can be carried out in the down hand position. Make sure that the Work Lead/Clamp is making good electrical contact with the work, either directly or through the work table. For light gauge material, always clamp the work lead directly to the job, otherwise a poor circuit will probably result.

11.7.2 The Welder

Place yourself in a comfortable position before beginning to weld. Get a seat of suitable height and do as much work as possible sitting down. Don't hold your body tense. A taut attitude of mind and a tensed body will soon make you feel tired. Relax and you will find that the job becomes much easier. You can add much to your peace of mind by wearing a leather apron and gauntlets. You won't be worrying then about being burnt or sparks setting alight to your clothes.

Place the work so that the direction of welding is across, rather than to or from, your body. The electrode holder lead should be clear of any obstruction so that you can move your arm freely along as the electrode burns down. If the lead is slung over your shoulder, it allows greater freedom of movement and takes a lot of weight off your hand. Be sure the insulation on your cable and electrode holder is not faulty; otherwise you are risking an electric shock.

11.7.3 Striking the Arc

Practice this on a piece of scrap plate before going on to more exacting work.

You may at first experience difficulty due to the tip of the electrode "sticking" to the work piece. This is caused by making too heavy a contact with the work and failing to withdraw the electrode quickly enough. A low amperage will accentuate it. This freezing on of the tip may be overcome by scratching the electrode along the plate surface in the same way as a match is struck.

Another difficulty you may meet is the tendency, after the arc is struck, to withdraw the electrode so far that the arc is broken again. A little practice will soon remedy both of these faults.

Striking an Arc

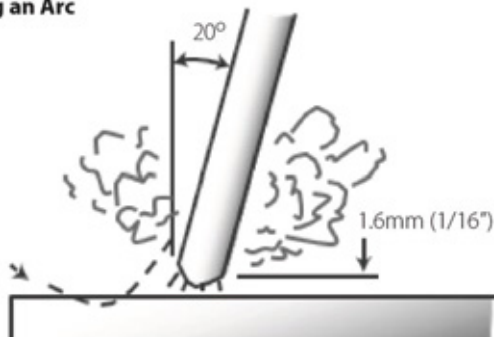

Figure 30



EZITIG 205 AC/DC

11.7.4 Arc Length

As soon as the arc is established, maintain a 1.6mm to 3.2mm gap between the burning electrode end and the parent metal. Draw the electrode slowly along as it melts down. The securing of an arc length necessary to produce a neat weld soon becomes almost automatic. You will find that a long arc produces more heat.

A very long arc produces a crackling or spluttering noise and the weld metal comes across in large, irregular blobs. The weld bead is flattened and spatter increases. A short arc is essential if a high quality weld is to be obtained although if it is too short there is the danger of it being blanketed by slag and the electrode tip being solidified in. If this should happen, give the electrode a quick twist back over the weld to detach it.

11.7.5 Rate of Travel

After the arc is struck, your next concern is to maintain it, and this requires moving the electrode tip towards the molten pool at the same rate as it is melting away. At the same time, the electrode has to move along the plate to form a bead.

The electrode is directed at the weld pool at about 20° from the vertical. The rate of travel has to be adjusted so that a well-formed bead is produced.

If the travel is too fast, the bead will be narrow and strung out and may even be broken up into individual globules. If the travel is too slow, the weld metal piles up and the bead will be too large.

11.8 Making Welded Joints

Having attained some skill in the handling of an electrode, you will be ready to go on to make up welded joints.

11.8.1 Butt Welds

Set up two plates with their edges parallel, as shown in Figure 31, allowing 1.6mm to 2.4mm gap between them and tack weld at both ends. This is to prevent contraction stresses from the cooling weld metal pulling the plates out of alignment.

Plates thicker than 6.0mm should have their mating edges beveled to form a 70° to 90° included angle. This allows full penetration of the weld metal to the root. Using a 3.2mm Stick electrode at 100 amps, deposit a run of weld metal on the bottom of the joint.

Do not weave the electrode, but maintain a steady rate of travel along the joint sufficient to produce a well-formed bead. At first you may notice a tendency for undercut to form, but keeping the arc length short, the angle of the electrode at about 20° from vertical, and the rate of travel not too fast, will help eliminate this.

The electrode needs to be moved along fast enough to prevent the slag pool from getting ahead of the arc. To complete the joint in thin plate, turn the job over, clean the slag out of the back and deposit a similar weld.

Heavy plate will require several runs to complete the joint. After completing the first run, chip the slag out and clean the weld with a wire brush. It is important to do this to prevent slag being trapped by the second run. Subsequent runs are then deposited using either a weave technique or single beads laid down in the sequence shown in Figure 32. The width of weave should not be more than three times the core wire diameter of the electrode.

When the joint is completely filled, the back is either machined, ground or gouged out to remove slag which may be trapped in the root, and to prepare a suitable joint for depositing the backing run. If a backing bar is used, it is not usually necessary to remove this, since it serves a similar purpose to the backing run in securing proper fusion at the root of the weld.

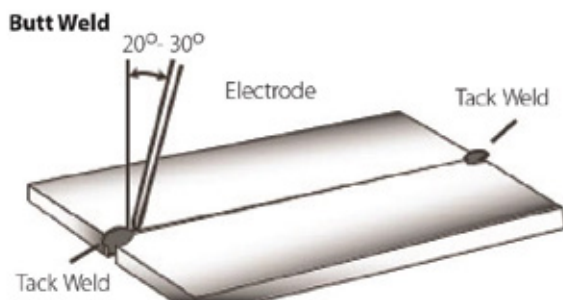

Figure 31

Weld Build Up Sequence

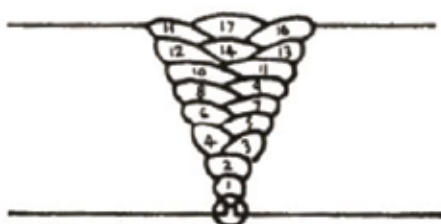

Figure 32



11.8.2 Fillet Welds

These are welds of approximately triangular cross-section made by depositing metal in the corner of two faces meeting at right angles. Refer Figure 33 and Figure 34.

A piece of angle iron is a suitable specimen with which to begin, or two lengths of strip steel may be tacked together at right angles. Using a 3.2mm Stick electrode at 100 amps, position angle iron with one leg horizontal and the other vertical. This is known as a horizontal-vertical (HV) fillet.

Strike the arc and immediately bring the electrode to a position perpendicular to the line of the fillet and about 45° from the vertical. Some electrodes require being sloped about 20° away from the perpendicular position to prevent slag from running ahead of the weld. Refer to Figure 33.

Do not attempt to build up much larger than 6.4mm width with a 3.2mm electrode, otherwise the weld metal tends to sag towards the base, and undercut forms on the vertical leg. Multi-runs can be made as shown in Figure below. Weaving in HV fillet welds is undesirable.

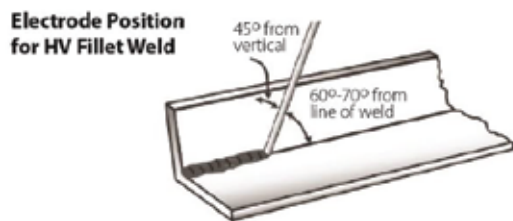

Figure 33



Figure 34

11.8.3 Vertical Welds

11.8.3.1 Vertical Up

Tack weld a three feet length of angle iron to your work bench in an upright position. Use a 3.2mm Stick electrode and set the current at 100 amps. Make yourself comfortable on a seat in front of the job and strike the arc in the corner of the fillet. The electrode needs to be about 10° from the horizontal to enable a good bead to be deposited.

Refer Figure 35.

Single Run Vertical Fillet Weld

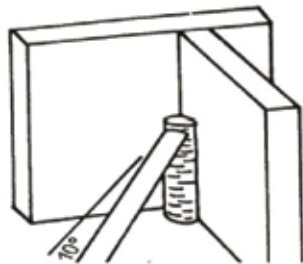

Figure 35

Use a short arc, and do not attempt to weave on the first run. When the first run has been completed deslag the weld deposit and begin the second run at the bottom. This time a slight weaving motion is necessary to cover the first run and obtain good fusion at the edges.

At the completion of each side motion, pause for a moment to allow weld metal to build up at the edges, otherwise undercut will form and too much metal will accumulate in the centre of the weld. Figure 36 illustrates multi-run technique and Figure 37 shows the effects of pausing at the edge of weave and of weaving too rapidly.

Multi Run Vertical Fillet Weld

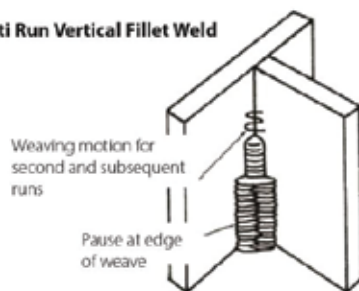

Figure 36

Examples of Vertical Fillet Welds

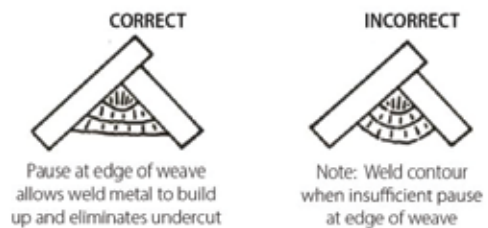

Figure 37

11.8.3.2 Vertical Down

The Stick electrode makes welding in this position particularly easy. Use a 3.2mm electrode at 100 amps. The tip of the electrode is held in light contact with the work and the speed of downward travel is regulated so that the tip of the electrode just keeps ahead of the slag. The electrode should point upwards at an angle of about 45°.

11.8.4 Overhead Welds

Apart from the rather awkward position necessary, overhead welding is not much more difficult than down hand welding. Set up a specimen for overhead welding by first tacking a length of angle iron at right angles to another piece of waste pipe. Then tack this to the work bench or hold in a vice so that the specimen is positioned in the overhead position as shown in the sketch.

The electrode is held at 45° to the horizontal and tilted 10° in the line of travel (Figure 38). The tip of the electrode may be touched lightly on the metal, which helps to give a steady run. A weave technique is not advisable for overhead fillet welds.

Use a 3.2mm Stick electrode at 100 amps, and deposit the first run by simply drawing the electrode along at a steady rate. You will notice that the weld deposit is rather convex, due to the effect of gravity before the metal freezes.

Overhead Fillet Weld

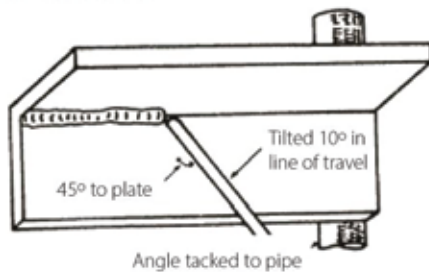
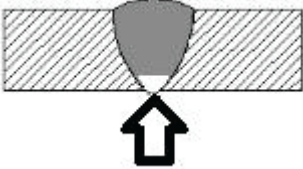
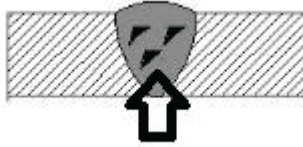
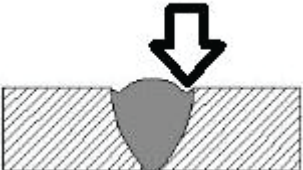

Figure 38

11.9 MMA (Stick) Troubleshooting

Fault	Cause	Remedy
<p>A gap is left by failure of the weld metal to fill the root of the weld.</p>  <p>Figure 39</p>	Welding current too low.	Increase welding current.
	Electrode too large for joint.	Use smaller diameter electrode.
	Insufficient gap.	Allow wider gap.
<p>Non-metallic particles are trapped in the weld metal.</p>  <p>Figure 40</p>	Non-metallic particles may be trapped in undercut from previous run.	If a bad undercut is present clean slag out and cover with a run from a smaller gauge electrode.
	Joint preparation too restricted.	Allow for adequate penetration and room for cleaning out the slag.
	Irregular deposits allow slag to be trapped.	If very bad, chip or grind out irregularities.
	Lack of penetrations with slag trapped beneath weld bead.	Use smaller electrode with sufficient current to give adequate penetrations. Use suitable tools to remove all slag from comers.
	Rust or mill scale or preventing full fusion.	Clean joint before welding.
	Wrong electrode for position in which welding is done.	Use electrodes designed for position in which welding is done, otherwise proper control of slag is difficult.
<p>A groove has been formed in the base metal adjacent to the top of a weld and has not been filled by the weld metal (undercut).</p>  <p>Figure 41</p>	Welding current is too high.	Reduce welding current.
	Welding arc is too long.	Reduce the length of the welding arc.
	Angle of the electrode is incorrect.	Electrode should not be inclined less than 45° to the vertical face.
	Joint preparation does not allow correct electrode angle.	Allow more room for joint for manipulation of the electrode.
	Electrode too large for joint.	Use smaller gauge electrode.
	Insufficient deposit time at edge of weave.	Pause for a moment at edge of weave to allow weld metal build-up.
	Power source is set for MIG (GMAW) welding.	Set power source to STICK (MMA) mode.



Fault	Cause	Remedy
Portions of the weld run do not fuse to the surface of the metal or edge of the joint.  Figure 42	Small electrodes used on heavy cold plate.	Use larger electrodes and preheat the plate.
	Welding current is too low.	Increase welding current.
	Wrong electrode angle.	Adjust angle so the welding arc is directed more into the base metal.
	Travel speed of electrode is too high.	Reduce travel speed of electrode.
	Scale or dirt on joint surface.	Clean surface before welding.
Gas pockets or voids in weld metal (porosity)  Figure 43	High levels of Sulphur in steel.	Use an electrode that is designed for high Sulphur steels.
	Electrodes are damp.	Dry electrodes before use.
	Welding current is too high.	Reduce welding current.
	Surface impurities such as oil, grease, paint, etc.	Clean joint before welding.
	Welding in a windy environment.	Shield the weld area from the wind.
	Electrode damaged i.e. flux coating incomplete.	Discard damaged electrodes and only use electrodes with a complete flux coating.
Crack occurring in weld metal soon after solidification commences  Figure 44	Rigidity of joint.	Redesign to relieve weld joint of severe or use crack resistance electrodes.
	Insufficient throat thickness.	Travel slightly slower to allow greater build up in throat.
	Weld current is too high.	Decrease welding current.

Table 8

12 TIG BASIC WELDING GUIDE

TIG Welding is a fusion procedure that uses an electric ARC created between an infusible tungsten electrode and base material to be welded. For TIG welding an inert gas must be used (Argon) which protects the welding bead. If filling material is used, it is made up of rods suitable to the material to be welded (steel, stainless steel, copper etc.).

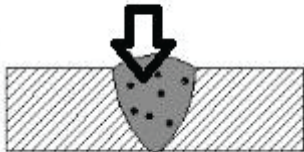
TIG Welding

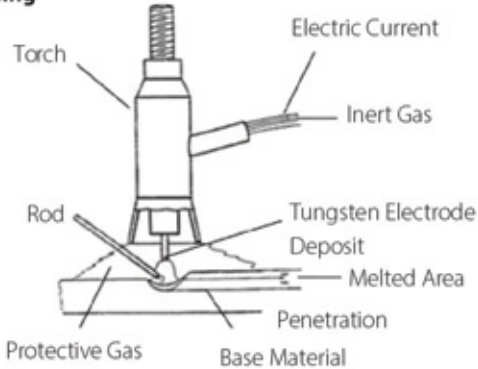

Figure 45

In TIG mode, welding is possible in all positions: flat, angle, on the edge, vertical and overhead. Furthermore, with respect to other types of welding, the welding joint has greater mechanical resistance, greater corrosion resistance and limited heating in the welded area which limits distortion. Welding can be done even without weld material, guaranteeing a smooth, shiny weld with no impurities or slag.

12.1 TIG Electrode Selection and Preparation

12.1.1 Tungsten Electrode Selection & Polarity

Connect the TIG torch to the negative (-) torch terminal and the work lead to the positive (+) work terminal for direct current straight polarity. Direct current straight polarity is the most widely used polarity for DC TIG welding. It allows limited wear of the electrode since 70% of the heat is concentrated at the work piece.

Tungsten Electrode Types			
Electrode Type	Application	Features	Colour Code
	All metals*	High-Performance, suitable for both DC (Steel, Stainless steel etc.) and AC (Aluminium) TIG welding. Maintains tip shape, reliable arc striking, low burn off rate, long service life and smooth/stable arc.	Purple

Table 9

Tungsten Electrode Current Ranges	
Electrode Diameter	DC Current (Amps)
1.6mm (1/16")	60 – 115
2.4mm (3/32")	100 – 165
3.2mm (1/8")	135 – 200

Table 10

Guide For Selecting Filler Wire Diameter	
Filler Electrode Diameter	DC Current (Amps)
1.6mm (1/16")	20 – 90
2.4mm (3/32")	65 – 115
3.2mm (1/8")	100 – 165

Table 11

12.1.2 Preparing Tungsten

The electrode should be pointed (tapered) according to the welding current. Grind end of tungsten on fine grit, hard abrasive wheel before welding. Do not use wheel for other jobs or tungsten can become contaminated causing lower weld quality. Rule of thumb is that the taper section should be 2.5 times the Electrode Diameter.

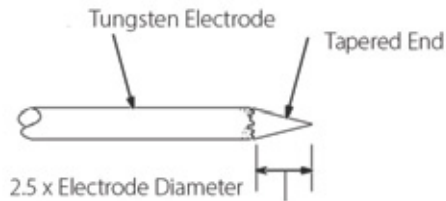

Figure 46

Ideal Tungsten Preparation = Stable ARC

Diameter of the flat left on the end of the Electrode determines amperage capacity.

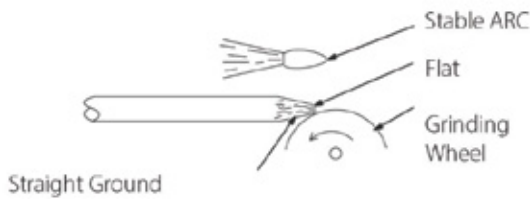

Figure 47

Wrong Tungsten Preparation = Wandering ARC

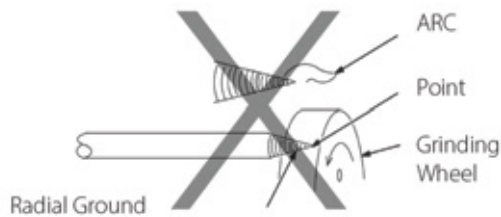

Figure 48

Pointing the Tungsten Electrode

The electrode should be pointed according to the welding current.



Figure 49

Electrode Angles	
Angle @	Range of Current (Amps)
30°	0 – 30
60-90°	30 -120
90-120°	120 - 250
120°	≥250

Table 12

Note that when welding in AC Mode the tungsten should automatically form a 'ball' shape on the end. This is perfectly normal and this is what is required for AC TIG welding.



EZITIG 205 AC/DC

12.1.3 Shielding Gas for TIG Welding

Shielding Gas Selection	
Alloy	Shielding Gas
Carbon Steel	100% Argon
Stainless Steel	
Nickel Alloy	
Copper	
Titanium	
Aluminium	

Table 13

12.1.4 Typical TIG Welding Settings

TIG Welding Settings For DC						
Metal Thickness	DC Current (Amps)		Tungsten Electrode Diameter	Filler Rod Diameter (if required)	Argon Gas Flow Rate L/min	Joint Type
	Mild Steel	Stainless Steel				
1.2mm (0.045")	45-55	30-45	1.0mm (0.040")	1.6mm (1/16")	5 - 10	Butt/ Corner
	50-60	35-50				Lap / Fillet
1.6mm (1/16")	60-70	40-60	1.6mm (1/16")	1.6mm (1/16")	10 - 15	Butt/ Corner
	70-90	50-70				Lap / Fillet
3.2mm (1/8")	80-100	65-85	1.6mm (1/16")	2.4mm (3/32")	10 - 15	Butt/ Corner
	90-115	90-110				Lap / Fillet

Table 14

TIG Welding Settings For AC			
Tungsten Electrode Diameter	AC Current (Amps)		Argon Gas Flow Rate L/min
	Unbalanced Wave	Balanced Wave	
1.0mm (0.040")	15-80	20-60	5 - 10
1.6mm (1/16")	70-150	60-120	10 - 15
2.4mm (3/32")	140-235	100-180	10 - 15

Table 15



EZITIG 205 AC/DC

12.2 Starting the Weld

12.2.1 Lift-Arc Ignition

Lift-Arc Ignition Function means that to start the arc the tungsten is touched on the job and lifted off. The ignition current is very low and therefore the tungsten barely sticks to the job and the sharpened point is not damaged. The tungsten is then easily lifted off the job. The machine senses that the contact is broken and begins the weld.

1. Press the Torch Trigger Button down and hold
2. Pre-Gas will start
3. Touch the Tungsten Electrode onto the Workpiece very briefly
4. Lift the Tungsten Electrode up slowly off the Workpiece
5. If set to 4T Trigger mode the Start Current will be maintained until you release the Torch Trigger Button and will then proceed to the Slope-Up process. If Set to 2T Trigger mode machine will proceed directly to the Slope-Up process.

12.2.2 HF Ignition

High-Frequency (HF) Ignition Function uses a high frequency arc to jump from the tungsten electrode to the workpiece to start the welding arc (eliminating the need for the tungsten electrode to make contact with the job).

1. Hold the Tungsten Electrode close to the workpiece (1-3mm). It is usually easiest to lie the torch over and rest the edge of the shield cup on the workpiece.
2. Press the Torch Trigger Button down
3. The machine will begin the 'Pre-Gas' time and then ignite the arc.
4. If set to 4T Trigger mode the Start Current will be maintained until you release the Torch Trigger Button and will then proceed to the Slope-Up process. If Set to 2T Trigger mode machine will proceed directly to the Slope-Up process.



12.3 Main Weld Current

12.3.1 DC Current

DC or Direct Current is where the welding current flows in only one direction. With a DC circuit 70% of the energy or heat is always on the positive side.

DC is used for welding the following materials:

- Mild Steel
- Stainless Steel
- Copper
- Titanium

12.3.2 AC Current

AC or Alternating Current is where the welding current flow oscillates back and forth in both directions. When reactive metals are exposed to air they form an oxide layer that insulates the base metal and prevents welding current flowing. It also contaminates the weld pool. Reverse current flow is required to break through/ clean off this oxide layer so that welding can take place, while the current flow during the positive cycle does the majority of the heating of the weld pool area.

AC is used for welding the following materials:

- Aluminium
- Aluminium Alloys
- Magnesium
- Zinc

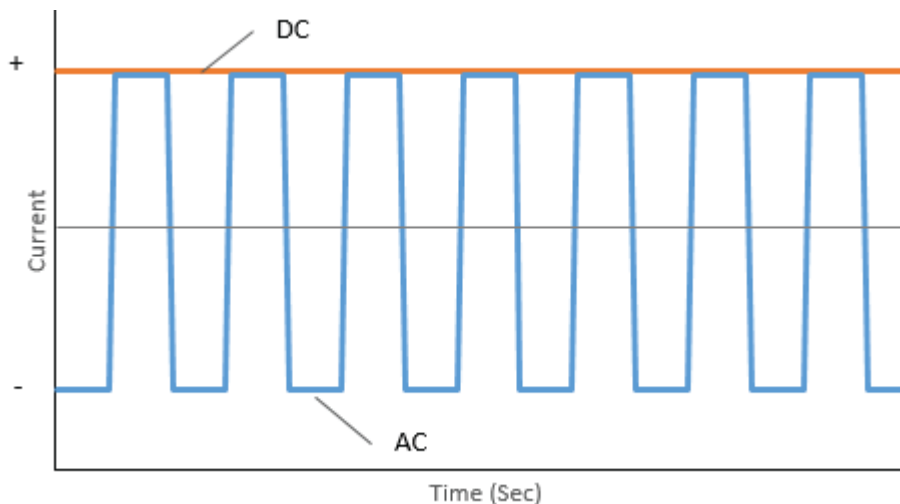

Figure 50



12.3.3 Pulse Welding

Pulse welding is where the Arc oscillates between high and low current/amperage.

It should not be confused with AC Current. AC refers to a change in the *direction* of the current flow whereas Pulse refers to a change the *amount* or Amperage of the current.

In Pulse mode the actual welding is done at the Peak of the Pulse. During the Trough of the Pulse the weld is allowed to cool which reduces the overall heat input into the workpiece.

There are several variables that can be adjusted in Pulse welding which allows for much better control of various aspects of the weld including:

- Heat input
- Penetration
- Operator Control
- Finished Weld Appearance

Pulse welding enables the operator to weld faster with better control and reduced heat which in turn minimises distortion of the work piece and gives a much better looking weld appearance.

The variables are explained further as follows:

Peak Current: this is the main welding current/amperage and which is used to melt the work piece and/or filler metal.

Trough Current: this is the lower current that allows the weld & work piece to cool. Generally this is set such that the weld pool is approximately half the size of the main weld pool during Peak Current.

Pulse Frequency: this controls how quickly the pulse oscillates (cycles per second) between Peak & Trough currents. The setting of this is predominately based on how the operator wants the finished weld bead to appear.

Pulse Width: this controls how much time is spent at the Peak Current vs the Trough Current. Increasing the Pulse Width percentage increase the time that is spent at the Peak Current which in turn increases the heat input into the job. Inversely reducing the Pulse Width percentage means more time is spent at the Trough Current which reduces heat input.

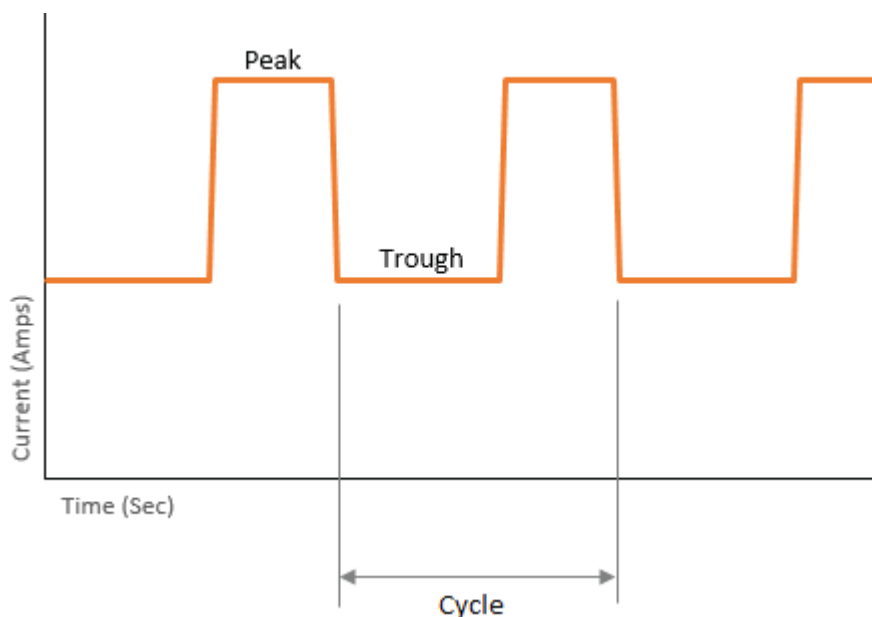

Figure 51



EZITIG 205 AC/DC

12.3.1 AC Balance

AC Balance is used to vary the proportion of time that the weld current flows in each direction.

The reverse part of the AC cycle is what breaks the oxide layer and 'cleans' the weld material. The forward cycle is what actually melts the weld material.

A neutral AC Balance setting is 0 which means that the current is flowing forwards for 50% of the time and in reverse for 50% of the time.

More Positive AC Balance will mean will give greater cleaning effect, less weld penetration and more heat in the Tungsten Electrode.

This gives the disadvantage of reducing the output current that can be used for a given tungsten size to prevent the tungsten overheating.

More Negative AC Balance will give the opposite effect, less cleaning effect, greater weld penetration and less heat in the tungsten.

Ideally for maximum effectiveness, AC balance should be set with as much Negative AC Balance as possible, while still maintaining a sufficient level of oxidation removal for a contamination free weld pool.

The cleaner the non-ferrous metal is before welding, the more effective it is to weld.

This effect can also be used to reduce heat in the tungsten, allowing use of a pointed tungsten tip shape for a more defined arc.

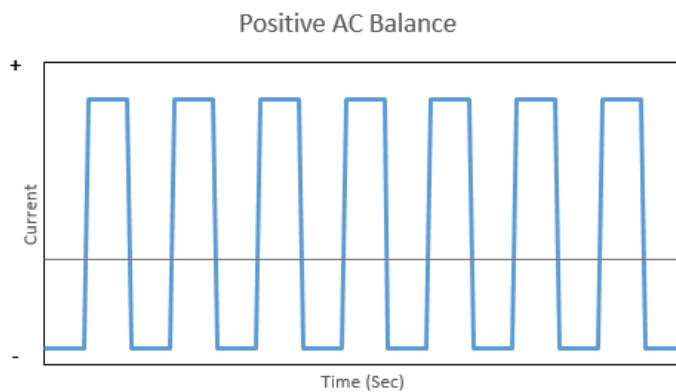

Figure 52

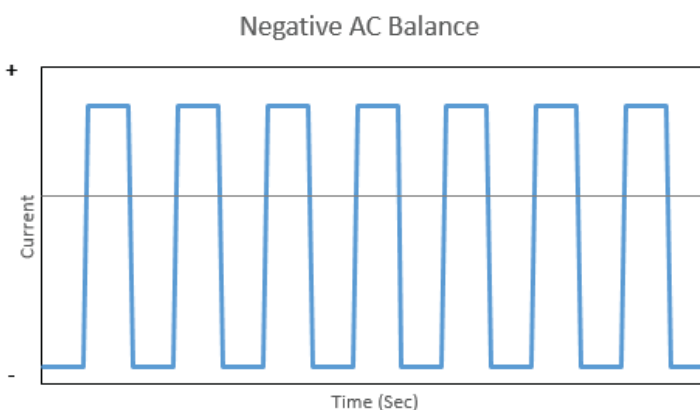

Figure 53



EZITIG 205 AC/DC

12.4 Finishing the Weld

In 2T Trigger Mode

1. Release the Torch Trigger Button
2. The welding current will gradually reduce down to zero to complete the Down-Slope process
3. The Post-Gas time will then complete

In 4T Trigger Mode

1. Press and Hold the Torch Trigger Button down
2. The welding current will gradually reduce down to the Finish-Current to complete the Down-Slope process
3. Release the Torch Trigger Button when you want the Finish-Current to stop
4. The Post-Gas time will then complete

12.4.1 Down-Slope

This gradually reduces the weld current over the time selected down to Finish Current. This allows the operator to complete the weld without leaving a 'crater' at the end of the weld pool.

12.4.1 Post Gas Flow

This controls the period of time the shielding gas continues to flow for after the arc stops. This protects the weld area and torch tungsten from contamination while it is still hot enough to react with atmospheric gases.

12.4.1 Finish Current

This gives a selected small amount of current which the operator can use to neatly complete the end of the weld.



12.5 TIG Welding Troubleshooting

Troubleshooting – TIG Weld quality		
Fault	Cause	Remedy
Excessive bead build up or poor penetration or poor fusion at edges of weld	Welding current is too low.	Increase weld current and/or faulty joint preparation
Weld bead too wide and flat or undercut at edges of weld or excessive burn through	Welding current is too high.	Decrease weld current.
Weld bead too small or insufficient penetration or ripples in bead are widely spaced apart.	Travel speed too fast.	Decrease weld current.
Weld bead too wide or excessive bead build up or excessive penetration in butt joint.	Travel speed too fast.	Increase travel speed.
Uneven leg length in fillet joint	Wrong placement of filler rod.	Re-position rod.
Electrode melts or oxidises when an arc is struck	Torch lead connected to positive welding terminal.	Connect torch lead to negative welding terminal.
	No gas flowing to welding region.	Check the gas lines for kinks or breaks and gas cylinder contents.
	Torch is clogged with dust or dirt.	Clean torch.
	Gas hose is cut.	Replace gas hose.
	Gas passage contains impurities.	Disconnect gas hose from the rear of Power Source then raise gas pressure and blow out impurities.
	Gas regulator turned off.	Turn on.
Dirty weld pool	Torch electrode is too small for the welding current.	Increase electrode diameter or reduce the welding current.
	Electrode contaminated by contact with work piece or filler rod material.	Clean the electrode by grinding off any contaminates.
	Work piece surface has foreign material on it.	Clean surface.
Poor weld pool	Gas contaminated with air.	Check gas lines for cuts and loose fitting or change gas cylinder.
	Inadequate shielding gas.	Increase gas flow or check gas line for gas flow problems.
Arc start is not smooth.	Increased gas flow or check gas line for gas flow problems.	Increase gas flow or check gas line for gas flow problems.
	Tungsten electrode is too large for the welding current.	Select the right size electrode.
	The wrong electrode is being used for the welding job.	Select the right electrode type.
	Gas flow rate is too high.	Select the right rate for the welding job.
	Incorrect shielding gas is being used.	Select the right shielding gas.
Arc flutters during TIG welding.	Poor Work Lead/Clamp connection to work piece.	Improve connection to work piece.
Arc flutters during TIG welding.	Tungsten electrode is too large for the welding current.	Select the right size electrode.

Table 16



13 KNOWLEDGE & RESOURCES

Please refer to Strata website www.strata.co.nz for more information.

14 SAFETY

14.1 Store and Retain this Manual

Retain this manual for the safety warnings and precautions, assembly, operating, inspection, maintenance and cleaning procedures. Write the product's serial number into the NOTES section at the rear, and keep this manual and the receipt in a safe and dry place for future reference.

14.2 Important Safety Information

Failure to follow the warnings and instructions may result in electric shock, fire, serious injury and/ or death. Save all warnings and instructions for future reference.

This is the safety alert symbol to alert you to potential personal injury hazards:



Obey all safety messages that follow this symbol to avoid possible injury or death.



DANGER! indicates a hazardous situation which, if not avoided, will result in death or serious injury.



WARNING! indicates a hazardous situation which, if not avoided, could result in death or serious injury.



CAUTION, used with the safety alert symbol, indicates a hazardous situation which, if not avoided, could result in minor or moderate injury.

NOTE, used to address practices not related to personal injury.

CAUTION, without the safety alert symbol, is used to address practices not related to personal injury.

14.3 Welding Operation

1. **Maintain labels and nameplates on the welder.** These carry important information. If unreadable or missing, contact Strata for a replacement.
2. **Avoid unintentional starting.** Make sure the welder is setup correctly and you are prepared to begin work before turning on the welder.
3. **Unplug before performing maintenance.** Always unplug the welder from its electrical outlet before performing any inspection, maintenance, or cleaning procedures.
4. **Never leave the welder unattended while energised.** Turn power off before leaving the welder unattended.



EZITIG 205 AC/DC

5. **Do not touch live electrical parts.** Wear dry, insulating gloves. Do not touch the electrode or the conductor tong with bare hands. Do not wear wet or damaged gloves.
6. **Protect yourself from electric shock.** Do not use the welder outdoors. Insulate yourself from the work piece and the ground. Use non-flammable, dry insulating material if possible, or use dry rubber mats, dry wood or plywood, or other dry insulating material large enough to cover the area of contact with the work or the ground.
7. **Avoid inhaling fume.** Some fume created by welding contain chemicals known to cause cancer, birth defects or other harm. Your risk from these exposures varies, depending on how often you do this type of work. To reduce your exposure to these chemicals, work in a well-ventilated area, and work with approved safety equipment, such as dust masks that are specially designed to filter out microscopic particles.
8. **People with pacemakers should consult their physician(s) before using this machine.**



WARNING! *Electromagnetic fields in close proximity to a heart pacemaker could cause interference, or failure of the pacemaker. The use of a Welder is NOT RECOMMENDED for pacemaker wearers. Consult your doctor.*

9. **Ensure that the unit is placed on a stable location before use.**



WARNING! *If this unit falls while plugged in, severe injury, electric shock, or fire may result.*

10. **Transportation Methods.** Lift unit with the handles provided, or use a handcart or similar device of adequate capacity. If using a fork lift vehicle, secure the unit to a skid before transporting.



CAUTION! *Disconnect input power conductors from de-energized supply line before moving the welding power source.*

11. **Exercise good work practices.** The warnings, precautions, and instructions discussed in this instruction manual cannot cover all possible conditions and situations that may occur. It must be understood by the operator that common sense and caution are factors which cannot be built into this product, but must be considered by the operator.
12. **Do not use this machine for pipe thawing.** This machine was not designed for pipe thawing and will be a significant electrical & heat hazard if attempt is made to use for thawing pipe.



EZITIG 205 AC/DC

14.4 Welding Safety Instructions & Warnings



WARNING! Protect yourself and others from possible serious injury or death. Keep children away. Read the operating/Instruction manual before installing, operating or servicing this equipment. Have all installation, operation, maintenance, and repair work performed by qualified people.

If an operator does not strictly observe all safety rules and take precautionary actions, welding products and welding processes can cause serious injury or death, or damage to other equipment or property.

Safe practices have developed from past experience in the use of welding and cutting. These practices must be learned through study and training before using this equipment. Some of these practices apply to equipment connected to power lines; other practices apply to engine driven equipment. Anyone not having extensive training in welding and cutting practices should not attempt to weld.

Safe practices are outlined in the Australian Standard AS 1674.2 entitled: Safety in Welding and European Standard EN60974-1 entitled: Safety in welding and allied processes.



WARNING! Only use safety equipment that has been approved by an appropriate standards agency. Unapproved safety equipment may not provide adequate protection. Eye and breathing protection must be AS/NZS compliant for the specific hazards in the work area.



DANGER! Always wear AS/NZS compliant safety glasses and full face shield fitted with appropriate filter shade number. (Refer Filter Table on page 17.)



CAUTION! Heavy-duty work gloves, non-skid safety shoes and hearing protection used for appropriate conditions will reduce personal injuries.



CAUTION! Have the equipment serviced by a qualified repair person using identical replacement parts. This will ensure that the safety of the power tool is maintained.



EZITIG 205 AC/DC

14.4.1 Personal Safety



CAUTION! *Keep the work area well lit. Make sure there is adequate space surrounding the work area. Always keep the work area free of obstructions, grease, oil, trash, and other debris. Do not use equipment in areas near flammable chemicals, dust, and vapours. Do not use this product in a damp or wet location.*

1. **Stay alert, watch what you are doing and use common sense when operating equipment.** Do not use a tool while you are tired or under the influence of drugs, alcohol or medication. A moment of distraction when operating equipment may result in serious personal injury.
2. **Do not overreach.** Keep proper footing and balance at all times. This enables better control of the power tool in unexpected situations.

14.4.2 Arc Rays can Burn Eyes and Skin



CAUTION! *Arc rays from the welding process produce intense heat and strong ultraviolet rays that can burn eyes and skin.*

1. Use a Welding Helmet or Welding Face Shield fitted with a proper shade filter (refer AS 60974-1, AS/NZS 1337.1 and AS/NZS 1338.1 Safety Standards) to protect your face and eyes when welding or watching. (See Filter Table on Page17).
2. Wear approved safety glasses. Side shields are recommended.
3. Use protective screens or barriers to protect others from flash and glare; warn others not to watch the arc.
4. Wear protective clothing made from durable, flame-resistant material (wool and leather) and foot safety protection.
5. Never wear contact lenses while welding.

14.4.3 Noise Can Damage Hearing



CAUTION! *Noise from some processes can damage hearing. Use AS/NZS compliant ear plugs or ear muffs if the noise level is high.*



EZITIG 205 AC/DC

14.4.4 Work Environment Safety



DANGER! Remove any combustible material from the work area.

1. When possible, move the work to a location well away from combustible materials. If relocation is not possible, protect the combustibles with a cover made of fire resistant material.
2. Remove or make safe all combustible materials for a radius of 10 metres around the work area. Use a fire resistant material to cover or block all doorways, windows, cracks, and other openings.
3. Enclose the work area with portable fire resistant screens. Protect combustible walls, ceilings, floors, etc., from sparks and heat with fire resistant covers.
4. If working on a metal wall, ceiling, etc., prevent ignition of combustibles on the other side by moving the combustibles to a safe location. If relocation of combustibles is not possible, designate someone to serve as a fire watch, equipped with a fire extinguisher, during the welding process and well after the welding is completed.
5. Do not weld or cut on materials having a combustible coating or combustible internal structure, as in walls or ceilings, without an approved method for eliminating the hazard.
6. After welding, make a thorough examination for evidence of fire. Be aware that visible smoke or flame may not be present for some time after the fire has started. Do not weld or cut in atmospheres containing dangerously reactive or flammable gases, vapours, liquids, and dust. Provide adequate ventilation in work areas to prevent accumulation of flammable gases, vapours, and dust.
7. Do not apply heat to a container that has held an unknown substance or a combustible material whose contents, when heated, can produce flammable or explosive vapours. Clean and purge containers before applying heat. Vent closed containers, including castings, before preheating, welding, or cutting.

14.4.5 Electricity Can Kill



DANGER! Touching live electrical parts can cause fatal shocks or severe burns.
The electrode and work circuit is electrically live whenever the output is on.

The input power circuit and machine internal circuits are also live when power is on. In semiautomatic or automatic wire welding, the wire, wire reel, drive roll housing, and all metal parts touching the welding wire are electrically live. Incorrectly installed or improperly grounded equipment is a hazard.

1. Do not touch live electrical parts.
2. Wear dry, hole-free insulating gloves and body protection.
3. Insulate yourself from the work and the ground using dry insulating mats or covers.
4. Disconnect input power before installing or servicing this equipment. Lock input power, disconnect switch open, or remove line fuses so power cannot be turned on accidentally.



EZITIG 205 AC/DC

5. Properly install and ground this equipment according to national, state, and local codes.
6. Turn off all equipment when not in use. Disconnect power to equipment if it will be left unattended or out of service.
7. Use fully insulated electrode holders. Never dip the holder in water to cool it or lay it down on the ground or the work surface. Do not touch holders connected to two welding machines at the same time or touch other people with the holder or electrode.
8. Do not use worn, damaged, undersized, or poorly spliced cables.
9. Do not wrap cables around your body.
10. Connect work piece to a good electrical ground.
11. Do not touch the electrode while in contact with the work (ground) circuit.
12. Use only well-maintained equipment. Repair or replace damaged parts as soon as practical.
13. In confined spaces or damp locations, do not use a welder with AC output unless equipped with a voltage reducer.

Arc rays from the welding process produce intense heat and strong ultraviolet rays that can burn eyes and skin. Use the following table to select the appropriate shade number for a Welding Helmet or Welding Face Shield.

Recommended Protection Fillers For Electric Welding		
Welding Process / Application	Approximate Range of Welding Current in Amps	Minimum Shade Number of Filter Lens
Stick (MMA)	Up to 100	8
	100 to 200	10
TIG	Up to 100	10
	100 to 200	11

Table 17

14.4.6 Fumes And Gases



WARNING! *Welding produces fumes and gases. Breathing these fumes and gases can be hazardous to your health.*

1. Keep your head out of the fumes. Do not breathe the fumes.
2. If inside, ventilate the area and/or use an exhaust at the arc to remove welding fumes and gases.
3. If ventilation is poor, use an approved supplied-air respirator (PAPR).
4. Read the Safety Data Sheets (SDS) and the manufacturer's instruction for the metals, consumables, coatings, and cleaners.
5. Work in a confined space only if it is well ventilated, or while wearing an air-supplied respirator. Shielding gases used for welding can displace air causing injury or death. Be sure the breathing air is safe.
6. Do not weld in locations near degreasing, cleaning, or spraying operations. The heat and rays of the arc can react with vapours to form highly toxic and irritating gases.
7. Do not weld on coated metals, such as galvanized, lead, or cadmium plated steel, unless the coating is removed from the weld area, the area is well ventilated, and if necessary, while wearing an air-supplied respirator. The coatings and any metals containing these elements can give off toxic fumes if welded.



EZITIG 205 AC/DC

14.4.7 Fire & Explosive Risks



WARNING! Sparks and spatter fly off from the welding arc. The flying sparks and hot metal, weld spatter, work piece, and hot equipment can cause fires and burns.

Accidental contact of electrode or welding wire to metal objects can cause sparks, overheating, or fire.

1. Protect yourself and others from flying sparks and hot metal.
2. Do not weld where flying sparks can strike flammable material.
3. Remove all flammables within 10m of the welding site.
4. Be alert that welding sparks and hot materials from welding can easily go through small cracks and openings to adjacent areas.
5. Watch for fire, and keep a fire extinguisher nearby.
6. Be aware that welding on a ceiling, floor, bulkhead, or partition can cause fire on the hidden side.
7. Do not weld on closed containers such as tanks or drums.
8. Connect the work lead/clamp to the job as close to the welding area as practical to prevent welding current from traveling long, possibly unknown paths and causing electric shock and fire hazards.
9. Do not use a welder to thaw frozen pipes.
10. Remove the stick electrode from the holder or cut off the welding wire at the contact tip when not in use.

14.4.8 Sparks & Hot Metal



WARNING! Chipping and grinding causes flying metal, and as welds cool they can throw off slag.

1. Wear an AS/NZS approved face shield or safety goggles. Side shields are recommended.
2. Wear appropriate safety equipment to protect the skin and body.



EZITIG 205 AC/DC

14.4.9 Gas Cylinders



WARNING! Gas cylinders contain gas under high pressure. If damaged, a cylinder can explode. Since gas cylinders are normally part of the welding process, be sure to treat them carefully.

1. Protect compressed gas cylinders from excessive heat, mechanical shocks, and arcs.
2. Install and secure cylinders in an upright position by chaining them to a stationary support or equipment cylinder rack to prevent falling or tipping.
3. Keep cylinders away from any welding or other electrical circuits.
4. Never allow a welding electrode to touch any cylinder.
5. Use appropriate shielding gas, regulators, hoses, and fittings designed for the specific application; maintain them and their associated parts in good condition.
6. Turn your face away from the valve outlet when opening the cylinder valve.



EZITIG 205 AC/DC

Warranty

As part of an on-going commitment to excellence in product support, Euroquip offers a comprehensive product warranty program.

In order to qualify for full warranty support, your product must be registered. Product not registered with Euroquip is supported by a base 12 month warranty only. Spare parts and technical support will not be available for an unregistered product outside of this base warranty period. If a Euroquip dealer has not already registered your product, please register it online or download a physical registration form at www.euroquip.co.nz.

Registered warranty period for the EZTIG205AC/DC:

Commercial Use: 24 Months

Domestic Use: 24 Months

Warranty covers failure caused by manufacturing and material defects in the product, during the warranty period specified. The warranty period begins when the product is purchased by the end user. Warranty is not transferrable and is only claimable by the original purchaser.

Warranty does not cover parts that are subject to wear and tear from usage.

Warranty covers failure of a product caused by defective materials and/or manufacturing for the period given and the usage specified by Euroquip. The warranty period begins when the product is purchased by the end user. Warranty is not transferrable and is only claimable by the original purchaser.

Warranty also does not cover failure caused by the untimely replacement or service of the above wearing parts. Evidence must be provided that the product has been maintained and serviced suitably for a claim to be considered under warranty.

Failure caused by incorrect operation of the product, lack of proper care and maintenance of the product, external damage, external circumstances such as contaminated fuel or poor water supply, modifications to the product, attempted repair/ service by a party other than an Approved Service Agent, is not covered under warranty.

Warranty does not cover pre delivery service and adjustment, or failure that may occur as a result of lack of/ incorrect pre delivery service and adjustment.

Warranty does not cover any incidental, indirect or consequential loss, damage or expense that may result from any defect, failure or malfunction of a product.

Should any issue be found to be a combination of a warranty failure and a non-warranty issue, the repair cost component to rectify and repair the non-warranty failure is the customers' full responsibility.

The decision that an issue with a product qualifies as a warranty claim is made at the sole jurisdiction of Euroquip.

No costs incurred will be considered under warranty if repairs are carried out by a party other than a Euroquip Approved Service Agent, unless with prior consent in writing from Euroquip.

It is the responsibility of the purchaser to deliver a product under warranty to the nearest relevant service agent or product reseller. Warranty does not cover call outs, mileage and freight costs.

If a product is repaired under warranty, parts and labour required for the repair will be supplied at no charge. Warranty assessment and repair will be scheduled and executed according to the normal work flow at the service location and depending on the availability of suitable replacement parts.

This warranty policy is an additional benefit and does not affect the legal rights of any end user, reseller or service agent.



Scan here to register your product

<http://www.euroquip.co.nz/Contact+Us/Product+Registration+Form.html>



EZITIG 205 AC/DC



EZITIG 205 AC/DC



EZITIG 205 AC/DC



Congratulations on your new STRATA product. We are proud to have you as our customer and will strive to provide you with the best service and reliability in the industry. This product is backed by our extensive warranty. To locate your nearest distributor or service agency visit www.strata.co.nz, or email us at CustomerService@euroquip.co.nz

www.strata.co.nz